

MASTIC[®]
by  **Ply Gem**



2025
SPECIFICATION GUIDE

MAKE MORE POSSIBLE.™



A leading manufacturer of
exterior building products
in North America

#1 windows

#1 vinyl siding
& accessories

#1 metal roofing
& wall systems

#1 turnkey stone
solutions





MAKE MORE POSSIBLE.

MASTIC SIDING AND ACCESSORIES combines premium exterior style with uncompromising performance so building professionals can create homes at the pinnacle of quality, resilience and curb appeal.

Leveraging advanced science, innovative engineering and cutting-edge R&D, Mastic siding solutions are designed to stand out—and stand up to mother nature at her worst. Plus, pros get access to more tools, more training, more support and more rewards from a partner who is relentlessly invested in their success.



**CUTTING-EDGE
INNOVATION**



**UNCOMPROMISING
PERFORMANCE**



**RELENTLESS
PARTNERSHIP**



[Learn More About Mastic](#)



[Pro Academy Training Videos](#)

Table of Contents

Vinyl Products

Vinyl and Polypropelene Siding

Cedar Discovery®	6
Western Extreme®	10
Structure® Home Insulation System™	12
Quest®	18
Solar Defense Universal Vinyl Siding Accessories	20
Carvedwood•44®	21
Charleston Beaded®	23
Board+Batten Designer Series®	24
Ovation™	25
Mill Creek™	27

Vinyl Siding Accessories

Universal Vinyl Siding Accessories	29
----------------------------------------------	----

Vinyl Soffit and Accessories

Ventura® Hidden Vent Soffit	38
Pro-Bead® Vinyl Soffit/Wainscot and Accessories	39
Pro-Select® Vinyl Soffit	40
Pro-Tech® Plus Vinyl Soffit	41
Universal Vinyl Soffit	43
Vinyl Soffit Accessories	45

Ply Gem Shutters and Accessories

Shutters	48
Door Surround Systems	56
Mantel Systems	58
Window Mantels	60
Mounting Blocks	61
E-Z Block™ Surface Mounts	67
Utility Vents	68
Gable Vents	71
Matrix Digital QR Code	75

Ply Gem Performance Metals

Trim Sheet and Trim Coil

Trim Sheet Mastic Colors	76
Trim Coil Mastic Colors	80
Trim Coil Contractor's Choice	83

Aluminum Siding and Accessories

Envoy® Aluminum Siding	84
Endurance® Aluminum Siding	85
Aluminum Siding Accessories	86

Aluminum Soffit and Fascia Accessories

Envoy® Aluminum Soffit	88
Endurance® Aluminum Soffit	92

Table of Contents

Economy Aluminum Soffit	94
Aluminum Fascia	96
Aluminum Soffit and Fascia Accessories	100
Roof and Eave Ventilation Products	104
<i>Gutter Coil and Accessories</i>	
Gutter Coil	105
Downspout Coil	106
Gutter Accessories	107
<i>Sectional Gutter and Downspouts</i>	
Gutter and Downspout Coil Accessories	112
Metal Accessories Program for Fiber Cement	118
7" Rainware Program	119
Round Downspout Program	120
Envoy® 5" Aluminum Gutter and Accessories	121
Envoy® 6" Aluminum Gutter and Accessories	124
Envoy® Aluminum Downspouts and Accessories	126
<i>Gutter Protection Systems</i>	
Leaf Relief®	128
Leaf Logic™ & Leaf Smart™	135
<i>Roofing Accessories</i>	
T-Drip	136
F-Drip	137
C-Drip	138
Square Drip / Gutter Apron	139
Quick Drip / Gravel Stop	140
Ply Gem Trim & Mouldings	141
Specifications and Conformance	158

Product / Color Reference Charts



**Mastic Vinyl Siding
and Accessories
Color Matrix**



**Ply Gem Accessories
(Designer Accents)
Color Matrix**



**Ply Gem Metal
(Performance Metals)
Color Reference Matrix**

Cedar Discovery®

Product Code/Description

CD70P2

Cedar Discovery Perfection Shingle Double 7"

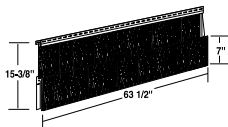

- Nominal Thickness: .080
- Panel Length: 67-3/4"
- Exposed Length: 64"
- 8 Pcs./Ctn.
- .5 Sq./Ctn.
- 34 Lbs./Ctn.

Note: 3/4" minimum vinyl siding accessories are required for installation.

Color Availability

- | | |
|-------------------|---------------------|
| White | Red Brick |
| Almond | Rock Harbor |
| Alpine Forest | Rugged Canyon |
| Autumn Harvest | Russet Red |
| Brandy Wood | Sage |
| Cameo | Sandtone |
| Classic Cream | Scottish Thistle |
| Colonial Yellow | Silver Grey |
| Corn Silk | Terra Cotta |
| Deep Cavern | Tuscan Olive |
| Deep Granite | Victorian Grey |
| Desert Sand | Whispering Timber |
| English Wedgewood | Wicker |
| Everest | Woodland Retreat |
| Harbor Grey | Cedar Colors |
| Lakeshore Fern | Cape Grey |
| Linen | Cedar |
| Misty Shadow | Red Cedar |
| Montana Suede | Timber |
| Natural Slate | Walnut |
| Newport Bay | |
| Pebblestone Clay | |
| Portsmouth Blue | |
| Quiet Willow | |

CD50P2

Cedar Discovery Perfection Shingle Triple 5"

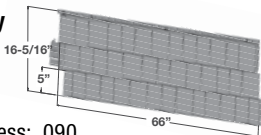

- Nominal Thickness: .090
- Panel Length: 69-1/2"
- Exposed Length: 63"
- 7 Pcs./Ctn.
- .46 Sq./Ctn.
- 35 Lbs./Ctn.

Note: 3/4" minimum vinyl siding accessories are required for installation.

- | | |
|-------------------|---------------------|
| White | Quiet Willow |
| Alpine Forest | Red Brick |
| Autumn Harvest | Rock Harbor |
| Brandy Wood | Rugged Canyon |
| Cameo | Russet Red |
| Colonial Yellow | Sage |
| Deep Cavern | Sandtone |
| Deep Granite | Scottish Thistle |
| Desert Sand | Silver Grey |
| English Wedgewood | Tuscan Olive |
| Everest | Victorian Grey |
| Harbor Grey | Whispering Timber |
| Lakeshore Fern | Wicker |
| Linen | Woodland Retreat |
| Misty Shadow | Cedar Colors |
| Montana Suede | Cape Grey |
| Natural Slate | Cedar |
| Newport Bay | Red Cedar |
| Pebblestone Clay | |

CD65HR

Cedar Discovery Half-Round

- Nominal Thickness: .080
- Panel Length: 51-3/4"
- Exposed Length: 48"
- 12 Pcs./Ctn.
- .5 Sq./Ctn.
- 39 Lbs./Ctn.

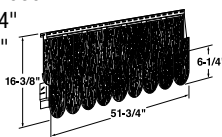

Note: 3/4" minimum vinyl siding accessories are required for installation.

- | |
|------------------|
| White |
| Classic Cream |
| Deep Granite |
| Everest |
| Harbor Grey |
| Lakeshore Fern |
| Pebblestone Clay |
| Russet Red |
| Wicker |

Note: We recommend using solid color accessories to coordinate with cedar colors. Good options include the following, however actual samples should be used for final selection: Cedar – Montana Suede; Pebblestone Clay; Rugged Canyon; Timber – Montana Suede, Red Cedar – Terra Cotta, Autumn Harvest; Cape Grey – Harbor Grey, Deep Granite; Walnut – Montana Suede, Autumn Harvest

Cedar Discovery®

Product Code/Description

CD95HS

Cedar Discovery Hand-Split Shake

- Panel Length: 67-3/4"
- Exposed Length: 64"
- 6 Pcs./Ctn.
- .5 Sq./Ctn.
- 41 Lbs./Ctn.

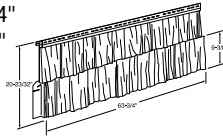

Note: 7/8" minimum vinyl siding accessories are required for installation.

Color Availability

- | | |
|-------------------|---------------------|
| White | Rock Harbor |
| Almond | Rugged Canyon |
| Alpine Forest | Russet Red |
| Autumn Harvest | Sage |
| Brandy Wood | Sandtone |
| Corn Silk | Scottish Thistle |
| Deep Cavern | Silver Grey |
| Deep Granite | Terra Cotta |
| Desert Sand | Tuscan Olive |
| English Wedgewood | Victorian Grey |
| Everest | Whispering Timber |
| Harbor Grey | Wicker |
| Lakeshore Fern | Woodland Retreat |
| Linen | |
| Misty Shadow | Cedar Colors |
| Montana Suede | Cape Grey |
| Natural Slate | Cedar |
| Newport Bay | Red Cedar |
| Pebblestone Clay | Timber |
| Portsmouth Blue | Walnut |
| Quiet Willow | |
| Red Brick | |

CD700CP2

Cedar Discovery Perfection Corner Post - Double 7"

- Nominal Thickness: .080
- Length: 29-1/8"
- 10 Pcs./Ctn.
- 12.30 Lbs./Ctn.



- | | |
|-------------------|---------------------|
| White | Quiet Willow |
| Almond | Red Brick |
| Alpine Forest | Rock Harbor |
| Autumn Harvest | Rugged Canyon |
| Brandy Wood | Russet Red |
| Cameo | Sage |
| Classic Cream | Sandtone |
| Colonial Yellow | Scottish Thistle |
| Corn Silk | Silver Grey |
| Deep Cavern | Terra Cotta |
| Deep Granite | Tuscan Olive |
| Desert Sand | Victorian Grey |
| English Wedgewood | Whispering Timber |
| Everest | Wicker |
| Harbor Grey | Woodland Retreat |
| Lakeshore Fern | |
| Linen | Cedar Colors |
| Misty Shadow | Cape Grey |
| Montana Suede | Cedar |
| Natural Slate | Red Cedar |
| Newport Bay | Timber |
| Pebblestone Clay | Walnut |
| Portsmouth Blue | |

CDP500CP

Cedar Discovery Perfection Corner Post - Triple 5"

- Nominal Thickness: .080
- Length: 31"
- 10 Pcs./Ctn.
- 19.50 Lbs./Ctn.



- | | |
|-------------------|---------------------|
| White | Red Brick |
| Alpine Forest | Rock Harbor |
| Autumn Harvest | Rugged Canyon |
| Brandy Wood | Russet Red |
| Cameo | Sage |
| Colonial Yellow | Sandtone |
| Deep Cavern | Scottish Thistle |
| Deep Granite | Silver Grey |
| Desert Sand | Terra Cotta |
| English Wedgewood | Tuscan Olive |
| Everest | Victorian Grey |
| Harbor Grey | Whispering Timber |
| Lakeshore Fern | Wicker |
| Linen | Woodland Retreat |
| Misty Shadow | |
| Montana Suede | Cedar Colors |
| Natural Slate | Cape Grey |
| Newport Bay | Cedar |
| Pebblestone Clay | Red Cedar |
| Quiet Willow | |



Cedar panels and accessories

Cedar Discovery®

Product Code/Description

Color Availability

CDHSOCP

**Cedar Discovery
Hand-Split Shake
Corner Post**

- Nominal Thickness: .080
- Length: 38"
- 10 Pcs./Ctn.
- 13 Lbs./Ctn.

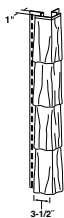

- White
- Almond
- Alpine Forest
- Autumn Harvest
- Brandy Wood
- Corn Silk
- Deep Cavern
- Deep Granite
- Desert Sand
- English Wedgewood
- Everest
- Harbor Grey
- Lakeshore Fern
- Linen
- Misty Shadow
- Montana Suede
- Natural Slate
- Newport Bay
- Pebblestone Clay
- Portsmouth Blue
- Quiet Willow
- Red Brick
- Rock Harbor
- Rugged Canyon
- Russet Red
- Sage
- Sandtone
- Scottish Thistle
- Silver Grey
- Tuscan Olive
- Victorian Grey
- Whispering Timber
- Wicker
- Woodland Retreat

CDSS

**Cedar Discovery
Starter Strip-Aluminum**

- Length: 10'
- 50 Pcs./Ctn.
- 33 Lbs./Ctn.

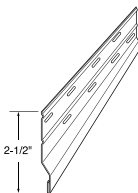

CPSSHD

**Cedar Discovery
Starter Strip-
Galvanized**

- Length: 10'
- 25 Pcs./Ctn.
- 49 Lbs./Ctn.

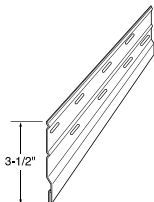

Cedar Colors

- Cape Grey
- Cedar
- Red Cedar
- Timber
- Walnut

Cedar Discovery®

Product Code/Description

Color Availability

SCMNT126

Snap-In Crown Mount

- Length: 12' 6"
- 40 Pcs./Ctn.
- 46 Lbs./Ctn.

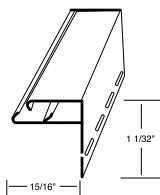

White

SCROWN126

Snap-In 3" Crown

- Length: 12' 6"
- 20 Pcs./Ctn.
- 55 Lbs./Ctn.

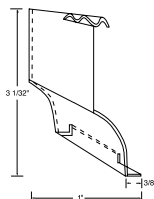

White

Light Colors

- Cameo
- Desert Sand
- Wicker

Classic Color

- Pebblestone Clay

Installing cedar panels



Cedar panels – last panel in eave & gable



How to replace a cedar panel



Western Extreme®

Product Code/Description

WE40

Western Extreme Double 4"

- Nominal Thickness: .048
- Finish: Woodgrain
- Length: 12' 6"
- 24 Pcs./Ctn.
- 2 Sqs./Ctn.
- 115.85 Lbs./Ctn.

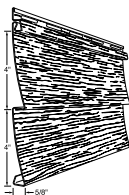

WED40

Western Extreme Double 4" Dutch Lap

- Nominal Thickness: .048
- Finish: Woodgrain
- Length: 12' 6"
- 24 Pcs./Ctn.
- 2 Sqs./Ctn.
- 116.45 Lbs./Ctn.

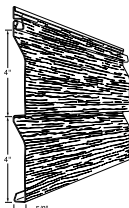

WE0SC4

Western Extreme Outside Corner Post Woodgrain 4" x 3/4" x 10'

- Finish: Woodgrain
- Length: 10'
- 10 Pcs./Ctn.
- 52 Lbs./Ctn.

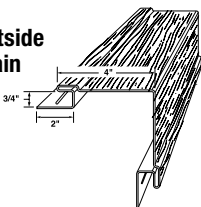

Color Availability

White

Light Colors

Desert Sand
Silver Grey
Victorian Grey
Wicker

Classic Colors*

Everest
Harbor Grey
Pebblestone Clay
Scottish Thistle

Deep Colors*

Brunswick
Deep Granite
English Wedgewood
Misty Shadow
Modern Iron
Montana Suede
Quiet Willow
Rugged Canyon
Vintage Dublin

*Classic and Deep Colors are Western Extreme Premium Colors

Classic Colors*

Everest
Harbor Grey
Pebblestone Clay
Scottish Thistle

Deep Colors*

Brunswick
Deep Granite
English Wedgewood
Misty Shadow
Modern Iron
Montana Suede
Quiet Willow
Rugged Canyon
Vintage Dublin

*Classic and Deep Colors are Western Extreme Premium Colors

**Installing
vertical siding**



Western Extreme® Board+Batten

Product Code/Description

WEBB70

**Board+Batten
Designer Series
5-1/2" Board with
1-1/2" Batten**

- Nominal Thickness: .048
- Length: 10'
- 17 Pcs./Ctn.
- 1 Sqs./Ctn.
- 54 Lbs./Ctn.

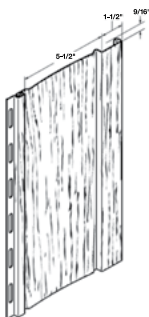

Color Availability

**Western Extreme
Technology
Colors**
Brunswick
Montana Suede
Misty Shadow

VINYL PRODUCTS

Structure® Home Insulation System®

Product Code/Description

SRD61EPS

**Structure
Double 6"**

- Nominal Thickness: 1.25"
- Length: 12' 6"
- 8 Pcs./Ctn.
- 1 Sq./Ctn.
- 62 Lbs./Ctn.
- Foam: EPS

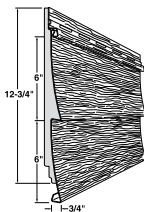

Color Availability

- | | |
|-----------------------|--------------------|
| White | Everest |
| Light Colors | Harbor Grey |
| Almond | Pebblestone Clay |
| Cameo | Scottish Thistle |
| Classic Cream | Deep Colors |
| Desert Sand | Autumn Harvest |
| Linen | Deep Granite |
| Sage | English Wedgewood |
| Sandtone | Misty Shadow |
| Silver Grey | Montana Suede |
| Victorian Grey | Quiet Willow |
| Wicker | Rugged Canyon |
| Classic Colors | Russet Red |
| Corn Silk | |

SRS71EPS

**Structure
Single 7"**

- Nominal Thickness: 1.25"
- Length: 12' 3"
- 14 Pcs./Ctn.
- 1 Sq./Ctn.
- 68 Lbs./Ctn.
- Foam: EPS

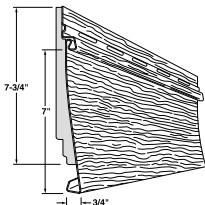

- | | |
|---------------------|----------------------|
| White | Classic Color |
| Light Colors | Harbor Grey |
| Almond | Pebblestone Clay |
| Cameo | Scottish Thistle |
| Classic Cream | Deep Color |
| Desert Sand | English Wedgewood |
| Linen | Montana Suede |
| Sage | Quiet Willow |
| Sandtone | Rugged Canyon |
| Silver Grey | |
| Victorian Grey | |
| Wicker | |
| Everest | |

Installing
vinyl siding
panels



Replacing
panels and
outside
corners



Foam-backed
siding options



Structure® Home Insulation System®

Product Code/Description

SRD41EPS

**Structure
Double 4"**

- Nominal Thickness: 1.25"
- Length: 12' 6"
- 12 Pcs./Ctn.
- 1 Sq./Ctn.
- 64 Lbs./Ctn.
- Foam: EPS

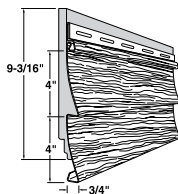

Color Availability

White

Light Colors

- Almond
- Cameo
- Classic Cream
- Desert Sand
- Linen
- Sage
- Sandtone
- Silver Grey
- Victorian Grey
- Wicker

Classic Colors

- Everest
- Harbor Grey
- Pebblestone Clay
- Scottish Thistle

SRD451EPS

**Structure
Double 4-1/2" Dutch Lap**

- Nominal Thickness: 1.25"
- Length: 12' 1"
- 11 Pcs./Ctn.
- 1 Sq./Ctn.
- 65 Lbs./Ctn.
- Foam: EPS

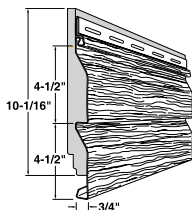

White

Light Colors

- Almond
- Cameo
- Classic Cream
- Desert Sand
- Linen
- Sage
- Sandtone
- Silver Grey
- Victorian Grey
- Wicker

Classic Colors

- Everest
- Harbor Grey
- Pebblestone Clay
- Scottish Thistle

Deep Colors

- English Wedgewood
- Montana Suede
- Quiet Willow
- Rugged Canyon

Structure®

Home Insulation System®

 Product Code/Description

SRD61EPSLS

Long Length Structure Double 6"

- Nominal
Thickness: 1.25"
- Length: 16' 8"
- 6 Pcs./Ctn.
- 1 Sq./Ctn.
- 66 Lbs./Ctn.
- Foam: EPS

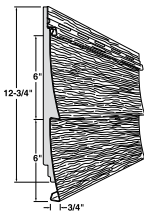

 Color Availability

White

Light Colors

Desert Sand
Sandtone
Victorian Grey
Wicker

Classic Colors

Everest
Harbor Grey
Pebblestone Clay
Scottish Thistle

Deep Colors

Autumn Harvest
Deep Granite
Misty Shadow
Montana Suede
Quiet Willow
Rugged Canyon
Russet Red

Structure®

Home Insulation System® Accessories

Product Code/Description	Color Availability
--------------------------	--------------------

SRLIN5

Structure 5" Corner Lineal with EPS Foam

- Length: 20'
- 10 Pcs./Ctn.
- 80 Lbs./Ctn.

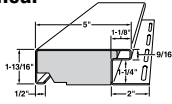

White

SRLIN35

Structure 3-1/2" Window and Door Casing Lineal with EPS Foam

- Length: 20'
- 10 Pcs./Ctn.
- 68 Lbs./Ctn.

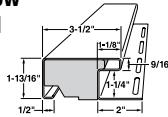

White

LINQRS

Corner Starter and Lineal

- Length: 20'
- 10 Pcs./Ctn.
- 68 Lbs./Ctn.

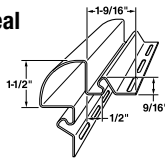

White

SCROWN126

Snap-In Crown 3" Crown

- Length: 12' 6"
- 20 Pcs./Ctn.
- 55 Lbs./Ctn.

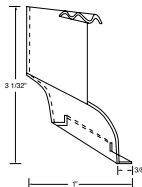

White

- Light Colors**
- Cameo
 - Desert Sand
 - Wicker

- Classic Color**
- Pebblestone Clay

Structure® Home Insulation System® Accessories

Product Code/Description

Color Availability

SRICP125

Structure Inside Corner Post 1-1/4"

- Length: 10'
- 4 Pcs./Ctn.
- 7.41 Lbs./Ctn.

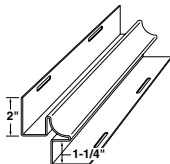

White

Light Colors

- Almond
- Cameo
- Classic Cream
- Desert Sand
- Linen
- Sage
- Sandtone
- Silver Grey
- Victorian Grey
- Wicker

Classic Colors

- Corn Silk
- Everest
- Harbor Grey
- Pebblestone Clay
- Scottish Thistle

Deep Colors

- Autumn Harvest
- Deep Granite
- English Wedgewood
- Misty Shadow
- Montana Suede
- Quiet Willow
- Rugged Canyon
- Russet Red

SROCP4

Structure 4" Corner Post with EPS Foam

- Length: 12'
- 4 Pcs./Ctn.
- 21.7 Lbs./Ctn.

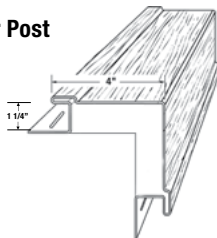

SRSS

Structure Starter Strip

- Length: 12' 6"
- 24 Pcs./Ctn.
- 46 Lbs./Ctn.

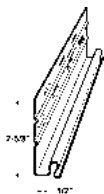

White

MVJ125

All Purpose J-Channel - 1-1/4" 1" Face

- Length: 12' 6"
- 20 Pcs./Ctn.
- 29.5 Lbs./Ctn.

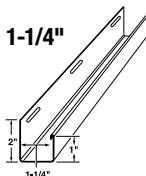

White

Light Colors

- Almond
- Cameo
- Classic Cream
- Desert Sand
- Linen
- Sage
- Sandtone
- Silver Grey
- Victorian Grey
- Wicker

Classic Colors

- Corn Silk
- Everest
- Harbor Grey
- Pebblestone Clay
- Scottish Thistle

Deep Colors

- Autumn Harvest
- Deep Granite
- English Wedgewood
- Misty Shadow
- Montana Suede
- Quiet Willow
- Rugged Canyon
- Russet Red

Structure®

Home Insulation System® Accessories

 Product Code/Description

 Color Availability

WCT12

2-1/2" Wide Window Casing Trim - 1-1/4"

- Length: 12' 6"
- 20 Pcs./Ctn.
- 66 Lbs./Ctn.

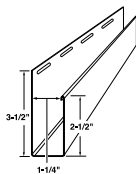

White

MVFJ061

Flexible J-Channel - 1-1/4"

- Length: 12' 6"
- 20 Pcs./Ctn.
- 66 Lbs./Ctn.
- Throat width: 1-1/4"

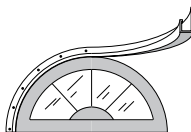

White

Note: For use with Structure
Home Insulation System™.

Quest®

Product Code/Description

QT40

Quest Double 4"

- Nominal Thickness: .046
- Length: 12' 6"
- 24 Pcs./Ctn.
- 2 Sqs./Ctn.
- 120 Lbs./Ctn.



Color Availability

White

Light Colors

- Almond
- Cameo
- Classic Cream
- Colonial Yellow
- Desert Sand
- Linen
- Sage
- Sandtone
- Silver Grey
- Tuscan Olive
- Victorian Grey
- Wicker

Deep Colors

- Autumn Harvest
- Deep Granite
- English Wedgewood
- Lakeshore Fern
- Misty Shadow
- Montana Suede
- Portsmouth Blue
- Quiet Willow
- Rugged Canyon
- Russet Red

Cedar Colors

- American Walnut
- Cape Cod Grey
- Glacier Blue
- Natural Cedar
- Timberstone
- Woodland Green

Classic Colors

- Corn Silk
- Everest
- Harbor Grey
- Pebblestone Clay
- Scottish Thistle

QT50

Quest Double 5"

- Nominal Thickness: .046
- Length: 12'
- 20 Pcs./Ctn.
- 2 Sqs./Ctn.
- 111 Lbs./Ctn.

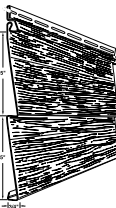

White

Light Colors

- Almond
- Cameo
- Classic Cream
- Colonial Yellow
- Desert Sand
- Linen
- Sage
- Sandtone
- Silver Grey
- Tuscan Olive
- Victorian Grey
- Wicker

Classic Colors

- Corn Silk
- Everest
- Harbor Grey
- Pebblestone Clay
- Scottish Thistle

Deep Colors

- Deep Granite
- English Wedgewood
- Quiet Willow
- Rugged Canyon

QTD45

Quest Double 4-1/2" Dutch Lap

- Nominal Thickness: .046
- Length: 12' 1"
- 22 Pcs./Ctn.
- 2 Sqs./Ctn.
- 116 Lbs./Ctn.

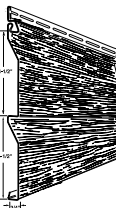

White

Light Colors

- Almond
- Cameo
- Classic Cream
- Colonial Yellow
- Desert Sand
- Linen
- Sage
- Sandtone
- Silver Grey
- Tuscan Olive
- Victorian Grey
- Wicker

Deep Colors

- Autumn Harvest
- Deep Granite
- English Wedgewood
- Lakeshore Fern
- Misty Shadow
- Montana Suede
- Portsmouth Blue
- Quiet Willow
- Rugged Canyon
- Russet Red

Cedar Colors

- American Walnut
- Cape Cod Grey
- Glacier Blue
- Natural Cedar
- Timberstone
- Woodland Green

Classic Colors

- Corn Silk
- Everest
- Harbor Grey
- Pebblestone Clay
- Scottish Thistle



Vinyl siding profile options

Quest®

Product Code/Description

QT40LS

Long Length Quest Double 4"

- Nominal Thickness: .046
- Length: 16' 8"
- 18 Pcs./Ctn.
- 2.04 Sqs./Ctn.
- 120 Lbs./Ctn.



Color Availability

White

Light Colors

Classic Cream
Desert Sand
Sandtone
Silver Grey
Tuscan Olive
Victorian Grey
Wicker

Classic Colors

Everest
Harbor Grey
Pebblestone Clay
Scottish Thistle

Deep Colors

Deep Granite
English Wedgewood
Misty Shadow
Montana Suede
Quiet Willow
Rugged Canyon

QTD45LS

Long Length quest Double 4 - 1/2"

Dutch Lap

- Nominal Thickness: .046
- Length: 16' 8"
- 16 Pcs./Ctn.
- 2 Sqs./Ctn.
- 116 Lbs./Ctn.

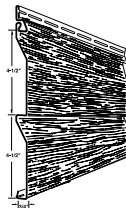

**Installing long
length panels**

SolarDefense® Universal Vinyl Siding Accessories

Product Code/Description

Color Availability

AWOP06

Universal Outside Corner Post Woodgrain 4" x 3/4" x 10'

- Finish: Woodgrain
- Length: 10'
- 10 Pcs./Ctn.
- 50 Lbs./Ctn.

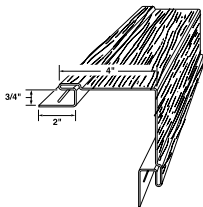

SolarDefense® Reflective Technology™

Alpine Forest
Brandy Wood
Deep Cavern
Natural Slate
Newport Bay
Red Brick
Rock Harbor
Whispering Timber
Woodland Retreat

MICP06

Inside Corner Post - 3/4"

- Length: 10'
- 10 Pcs./Ctn.
- 24.43 Lbs./Ctn.

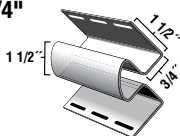

MVJ051

All Purpose J-Channel - 5/8" 1" Face

- Length: 12' 6"
- 40 Pcs./Ctn.
- 45 Lbs./Ctn.

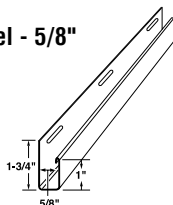

MVJ071

All Purpose J-Channel - 7/8" 1" Face

- Length: 12' 6"
- 40 Pcs./Ctn.
- 48 Lbs./Ctn.

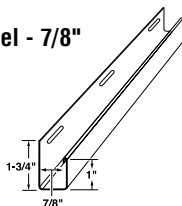

MFT

Finish Trim

- Length: 12' 6"
- 40 Pcs./Ctn.
- 46 Lbs./Ctn.

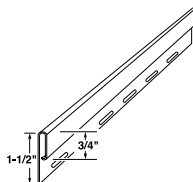

Carvedwood•44®

Product Code/Description

CW240

**Carvedwood•44
Double 4"**

- Nominal Thickness: .044
- Finish: Woodgrain
- Length: 12' 6"
- 24 Pcs./Ctn.
- 2 Sqs./Ctn.
- 109 Lbs./Ctn.

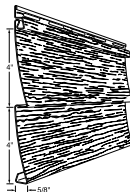

White

Light Colors

- Almond
- Cameo
- Classic Cream
- Colonial Yellow
- Desert Sand
- Linen
- Sage
- Sandstone
- Silver Grey
- Tuscan Olive
- Victorian Grey
- Wicker

Classic Colors

- Corn Silk
- Everest
- Harbor Grey
- Pebblestone Clay
- Scottish Thistle

Color Availability

Deep Colors

- Autumn Harvest
- Bayou Brunswick
- Deep Granite
- English Wedgewood
- Lakeshore
- Fern
- Misty Shadow
- Modern Iron
- Montana Suede
- Quiet Willow
- Rugged Canyon
- Russet Red
- Vintage Dublin

Solar Defense®

- Reflective Technology™**
- Alpine Forest
- Brandy Wood
- Deep Cavern
- Natural Slate
- Newport Bay
- Red Brick
- Rock Harbor
- Whispering Timber
- Woodland Retreat

CW250

**Carvedwood•44
Double 5"**

- Nominal Thickness: .044
- Finish: Woodgrain
- Length: 12'
- 20 Pcs./Ctn.
- 2 Sqs./Ctn.
- 101 Lbs./Ctn.

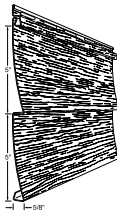

White

Light Colors

- Almond
- Cameo
- Classic Cream
- Colonial Yellow
- Desert Sand
- Linen
- Sage
- Sandtone
- Silver Grey
- Tuscan Olive
- Victorian Grey
- Wicker

Classic Colors

- Corn Silk
- Everest
- Harbor Grey
- Pebblestone Clay
- Scottish Thistle

Deep Colors

- Deep Granite
- English Wedgewood
- Quiet Willow
- Rugged Canyon

Carvedwood•44®

Product Code/Description

CW2D45

**Carvedwood•44
Double 4-1/2"**

Dutch Lap

- Nominal Thickness: .044
- Finish: Woodgrain
- Length: 12' 1"
- 22 Pcs./Ctn.
- 2 Sqs./Ctn.
- 105 Lbs./Ctn.

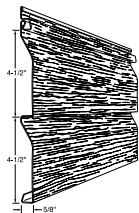

Color Availability

White

Light Colors

- Almond
- Cameo
- Classic Cream
- Colonial Yellow
- Desert Sand
- Linen
- Sage
- Sandtone
- Silver Grey
- Tuscan Olive
- Victorian Grey
- Wicker

Classic Colors

- Corn Silk
- Everest
- Harbor Grey
- Pebblestone Clay
- Scottish Thistle

Deep Colors

- Autumn Harvest
- Bayou
- Brunswick
- Deep Granite
- English Wedgewood
- Lakeshore Fern
- Misty Shadow
- Modern Iron
- Montana Suede
- Quiet Willow
- Rugged Canyon
- Russet Red
- Vintage Dublin

Solar Defense®

- Reflective Technology™**
- Alpine Forest
 - Brandy Wood
 - Deep Cavern
 - Natural Slate
 - Newport Bay
 - Red Brick
 - Rock Harbor
 - Whispering Timber
 - Woodland Retreat

CW230S

**Carvedwood•44
Triple 3"**

- Nominal Thickness: .044
- Finish: Smooth
- Length: 12' 1"
- 22 Pcs./Ctn.
- 2 Sqs./Ctn.
- 111 Lbs./Ctn.

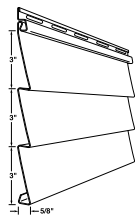

White

Light Colors

- Almond
- Cameo
- Classic Cream
- Colonial Yellow
- Desert Sand
- Linen
- Sandtone
- Silver Grey
- Tuscan Olive
- Victorian Grey
- Wicker

Classic Colors

- Everest
- Harbor Grey
- Pebblestone Clay
- Scottish Thistle

Deep Colors

- Deep Granite
- English Wedgewood
- Montana Suede
- Quiet Willow
- Rugged Canyon

CW80S

**Carvedwood•44
Single 8"**

- Nominal Thickness: .048
- Finish: Smooth
- Length: 12' 6"
- 24 Pcs./Ctn.
- 2 Sqs./Ctn.
- 113 Lbs./Ctn.

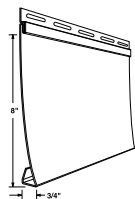

White

* 7/8" J Channel (MVJ071) required for installation

Charleston Beaded®

Product Code/Description

CB65

Charleston 6-1/2"**Contemporary Beaded**

- Nominal Thickness: .044
- Finish: Brushed
- Length: 12' 4"
- 30 Pcs./Ctn.
- 2 Sqs./Ctn.
- 115 Lbs./Ctn.

*Required Starter Strip: 1WAP10
(see Aluminum Siding Accessories)

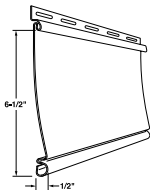

Color Availability

White

Light Colors

Almond
Cameo
Classic Cream
Desert Sand
Linen
Sage
Sandtone
Silver Grey
Victorian Grey
Wicker

Classic Colors

Everest
Pebblestone Clay
Scottish Thistle

**Installing horizontal
beaded siding**



Board+Batten Designer Series®

Product Code/Description

BB70

Board+Batten Designer Series 5-1/2" Board with 1-1/2" Batten

- Nominal Thickness: .048
- Length: 10'
- 17 Pcs./Ctn.
- 1 Sqs./Ctn.
- 54 Lbs./Ctn.

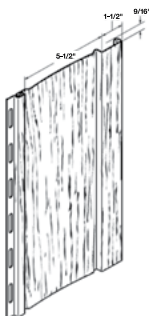

Color Availability

White

Light Colors

Almond
Classic Cream
Desert Sand
Sandtone
Tuscan Olive
Victorian Grey
Wicker

Classic Colors

Corn Silk
Everest
Harbor Grey
Pebblestone Clay
Scottish Thistle

Deep Colors

Autumn Harvest
Brunswick
Deep Granite
English Wedgewood
Lakeshore Fern
Misty Shadow
Montana Suede
Quiet Willow
Rugged Canyon
Russet Red
Vintage Dublin

Solar Defense® Reflective Technology™

Deep Cavern
Natural Slate
Newport Bay
Rock Harbor



Vertical
siding
options



Installing
vertical
siding

Ovation™

Product Code/Description

OV40

Ovation Double 4"

- Nominal Thickness: .042
- Finish: Woodgrain
- Length: 12' 6"
- 24 Pcs./Ctn.
- 2 Sqs./Ctn.
- 92 Lbs./Ctn.

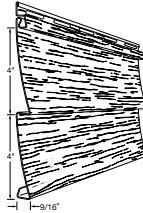

Color Availability

White

Light Colors

- Almond
- Cameo
- Classic Cream
- Desert Sand
- Linen
- Sage
- Sandtone
- Silver Grey
- Tuscan Olive
- Victorian Grey
- Wicker

Classic Colors

- Corn Silk
- Everest
- Harbor Grey
- Pebblestone Clay
- Scottish Thistle

Deep Colors

- English Wedgewood
- Deep Granite
- Misty Shadow
- Montana Suede
- Quiet Willow
- Rugged Canyon
- Vintage Dublin

Solar Defense®

Reflective Technology™

- Brandy Wood
- Natural Slate
- Newport Bay
- Red Brick

OV50

Ovation Double 5"

- Nominal Thickness: .042
- Finish: Woodgrain
- Length: 12'
- 20 Pcs./Ctn.
- 2 Sqs./Ctn.
- 95 Lbs./Ctn.

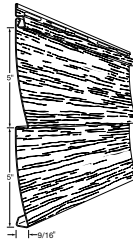

White

Light Colors

- Almond
- Cameo
- Classic Cream
- Desert Sand
- Linen
- Sage
- Sandtone
- Silver Grey
- Tuscan Olive
- Victorian Grey
- Wicker

Classic Colors

- Corn Silk
- Everest
- Harbor Grey
- Pebblestone Clay
- Scottish Thistle

Deep Colors

- English Wedgewood
- Deep Granite
- Quiet Willow
- Rugged Canyon

OVD45

Ovation Double 4.5" Dutch Lap

- Nominal Thickness: .042
- Finish: Woodgrain
- Length: 12' 1"
- 22 Pcs./Ctn.
- 2 Sqs./Ctn.
- 101 Lbs./Ctn.

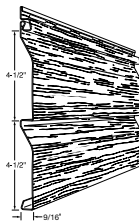

White

Light Colors

- Almond
- Cameo
- Classic Cream
- Desert Sand
- Linen
- Sage
- Sandtone
- Silver Grey
- Tuscan Olive
- Victorian Grey
- Wicker

Deep Colors

- English Wedgewood
- Deep Granite
- Misty Shadow
- Montana Suede
- Quiet Willow
- Rugged Canyon
- Vintage Dublin

Solar Defense®

Reflective Technology™

- Brandy Wood
- Natural Slate
- Newport Bay
- Red Brick

Classic Colors

- Corn Silk
- Everest
- Harbor Grey
- Pebblestone Clay
- Scottish Thistle

Ovation™

Product Code/Description

OV30S

Ovation Triple 3"

- Nominal Thickness: .042
- Finish: Brushed
- Length: 12' 1"
- 22 Pcs./Ctn.
- 2 Sqs./Ctn.
- 98 Lbs./Ctn.

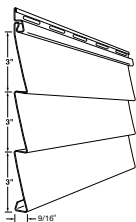

Color Availability

White

Light Colors

Cameo
 Classic Cream
 Desert Sand
 Linen
 Sandtone
 Silver Grey
 Tuscan Olive
 Victorian Grey
 Wicker

Classic Colors

Everest
 Harbor Grey
 Pebblestone Clay
 Scottish Thistle



**Installing horizontal
 beaded siding**

Mill Creek®

Product Code/Description

MC40

Mill Creek Double 4"

- Nominal Thickness: .040
- Length: 12' 6"
- 24 Pcs./Ctn.
- 2 Sqs./Ctn.
- 90 Lbs./Ctn.

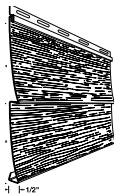

Color Availability

White

Light Colors

Almond
Cameo
Classic Cream
Desert Sand
Sandtone
Silver Grey
Tuscan Olive
Victorian Grey
Wicker

Classic Colors

Everest
Pebblestone Clay
Scottish Thistle

MC50

Mill Creek Double 5"

- Nominal Thickness: .040
- Length: 12'
- 20 Pcs./Ctn.
- 2 Sqs./Ctn.
- 85 Lbs./Ctn.

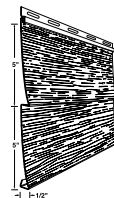

MCD40

Mill Creek Double 4" Dutch Lap

- Nominal Thickness: .040
- Length: 12' 6"
- 24 Pcs./Ctn.
- 2 Sqs./Ctn.
- 93 Lbs./Ctn.

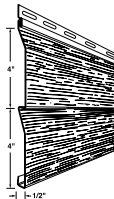

Mill Creek®

Product Code/Description

MCD45

Mill Creek Double 4.5" Dutch Lap

- Nominal Thickness: .040
- Length: 12' 1"
- 22 Pcs./Ctn.
- 2 Sqs./Ctn.
- 88 Lbs./Ctn.

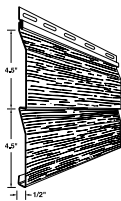

Color Availability

White

Light Colors

- Almond
- Cameo
- Classic Cream
- Desert Sand
- Sandtone
- Silver Grey
- Tuscan Olive
- Victorian Grey
- Wicker

Classic Colors

- Everest
 - Pebblestone Clay
 - Scottish Thistle
-

MCD50

Mill Creek Double 5" Dutch Lap

- Nominal Thickness: .040
- Length: 12'
- 20 Pcs./Ctn.
- 2 Sqs./Ctn.
- 86 Lbs./Ctn.

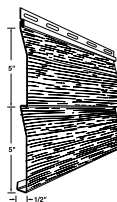

Universal Vinyl Siding Accessories

Product Code/Description

Color Availability

MVS250

Starter Strip Vinyl - 1/4"

- Length: 12' 6"
- 40 Pcs./Ctn.
- 69 Lbs./Ctn.

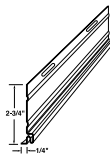

White

ASVSS25

Steel Starter Strip (galvanized)

- Length: 10'
- 25 Pcs./Ctn.
- 40 Lbs./Ctn.

(Not to be installed with aluminum siding)

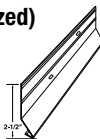

ASVSS35

Steel Starter Strip (galvanized)

- Length: 10'
- 25 Pcs./Ctn.
- 49 Lbs./Ctn.

(Not to be installed with aluminum siding)

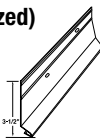

Starter strip

Universal Vinyl Siding Accessories

Product Code/Description

AWOP06

Universal Outside Corner Post Woodgrain 4" x 3/4" x 10'

- Finish: Woodgrain
- Length: 10'
- 10 Pcs./Ctn.
- 50 Lbs./Ctn.

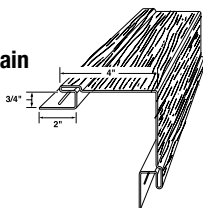

Color Availability

White

Light Colors

Almond
Cameo
Classic Cream
Colonial Yellow
Desert Sand
Linen
Sage
Sandtone
Silver Grey
Tuscan Olive
Victorian Grey
Wicker

Classic Colors

Corn Silk
Everest
Harbor Grey
Pebblestone Clay
Scottish Thistle

Deep Colors

Autumn Harvest
Bayou
Brunswick
Deep Granite
English Wedgewood
Lakeshore Fern
Misty Shadow

Modern Iron
Montana Suede
Portsmouth Blue
Quiet Willow
Rugged Canyon
Russet Red
Terra Cotta
Vintage Dublin

Cedar Colors

American Walnut
Cape Cod Grey
Glacier Blue
Natural Cedar
Timberstone
Woodland Green

Solar Defense® Reflective Technology™

Alpine Forest
Brandy Wood
Deep Cavern
Natural Slate
Newport Bay
Red Brick
Rock Harbor
Whispering Timber
Woodland Retreat

WOC306

Universal Outside Corner Post Woodgrain 3" x 3/4" x 10'

- Finish: Woodgrain
- Length: 10'
- 10 Pcs./Ctn.
- 37 Lbs./Ctn.

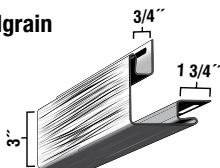

White

Light Colors

Almond
Cameo
Classic Cream
Desert Sand
Linen
Sandtone
Silver Grey
Tuscan Olive
Victorian Grey
Wicker

Classic Colors

Everest
Harbor Grey
Pebblestone Clay
Scottish Thistle



Flashing and
installing
corner posts



Replacing
panels and
outside corners



Corner post
options



Overlapping
and closing off
outside corners

Universal Vinyl Siding Accessories

Product Code/Description

Color Availability

MTOP06

Universal Outside Corner Post Matte
4" x 3/4" x 10'

- Finish: Matte
- Length: 10'
- 10 Pcs./Ctn.
- 51 Lbs./Ctn.

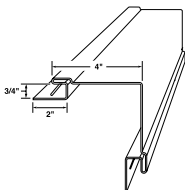

White

Light Colors

- Almond
- Cameo
- Desert Sand
- Linen
- Sandtone
- Silver Grey
- Victorian Grey
- Wicker

Classic Colors

- Everest
- Harbor Grey
- Pebblestone Clay
- Scottish Thistle

BAY0P06

Bay Corner - 3/4"

- Length: 10'
- 10 Pcs./Ctn.
- 33.4 lbs./CFA.

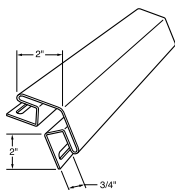

White

Classic Color

- Pebblestone Clay

MICP06

Inside Corner Post - 3/4"

- Length: 10'
- 10 Pcs./Ctn
- 24.43 Lbs./Ctn.

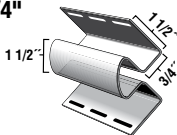

White

Light Colors

- Almond
- Cameo
- Classic Cream
- Colonial Yellow
- Desert Sand
- Linen
- Sage
- Sandtone
- Silver Grey
- Tuscan Olive
- Victorian Grey
- Wicker

Deep Colors

- Autumn Harvest
- Bayou
- Brunswick
- Deep Granite
- English Wedgewood
- Lakeshore Fern
- Misty Shadow
- Modern Iron
- Montana Suede
- Portsmouth Blue
- Quiet Willow
- Rugged Canyon

Classic Colors

- Corn Silk
- Everest
- Harbor Grey
- Pebblestone Clay
- Scottish Thistle

Cedar Colors

- American Walnut
- Cape Cod Grey
- Glacier Blue
- Natural Cedar
- Timberstone
- Woodland Green

Universal Vinyl Siding Accessories

 Product Code/Description

 Color Availability

TFOP55

Traditional 5-1/2" Outside Corner Post with Foam Insert

- Length: 20'
- 4 Pcs./Ctn.
- 67 Lbs./Ctn.

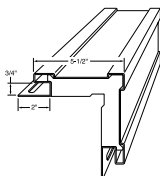

White

Light Colors

Cameo
Desert Sand
Wicker

Classic Color

Pebblestone Clay

FFOP55

Fluted 5-1/2" Outside Corner Post with Foam Insert

- Length: 20'
- 4 Pcs./Ctn.
- 67 Lbs./Ctn.

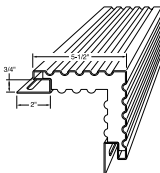

White

LINQRS

Corner Starter and Insert

- Length: 20'
- 10 Pcs./Ctn.
- 68 Lbs./Ctn.

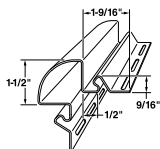

White

Universal Vinyl Siding Accessories

Product Code/Description

Color Availability

LIN5

5" Lineal

- Length: 20'
- 10 Pcs./Ctn.
- 78 Lbs./Ctn.

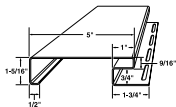

White

Light Colors

Cameo
Desert Sand

Classic Color

Pebblestone Clay

LIN35

3-1/2" Lineal

- Length: 20'
- 10 Pcs./Ctn.
- 65 Lbs./Ctn.

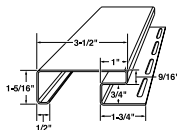

White

Light Colors

Cameo
Desert Sand

Classic Color

Pebblestone Clay

WCNCSS

New Construction Lineal Starter

- Length: 12' 6"
- 40 Pcs./Ctn.
- 40 Lbs./Ctn.

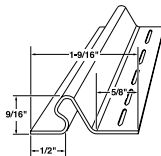

White

WCRSS

Remodeling Lineal Starter

- Length: 12' 6"
- 40 Pcs./Ctn.
- 58 Lbs./Ctn.

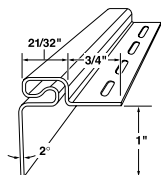

White



Installing
lineals as band
boards and
gables

Installing lineals
around new
& remodeled
windows



Universal Vinyl Siding Accessories

Product Code/Description

MVJ051
All Purpose J-Channel - 5/8"
1" Face

- Length: 12' 6"
- 40 Pcs./Ctn.
- 45 Lbs./Ctn.

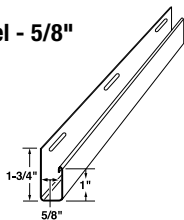

Color Availability

- White
- Light Colors**
- Almond
- Cameo
- Classic Cream
- Colonial Yellow
- Desert Sand
- Linen
- Sage
- Sandtone
- Silver Grey
- Tuscan Olive
- Victorian Grey
- Wicker
- Classic Colors**
- Corn Silk
- Everest
- Harbor Grey
- Pebblestone Clay
- Scottish Thistle
- Deep Colors**
- Autumn Harvest
- Bayou
- Brunswick
- Deep Granite
- English Wedgewood
- Lakeshore Fern
- Misty Shadow
- Modern Iron
- Montana Suede
- Portsmouth Blue
- Quiet Willow
- Rugged Canyon
- Russet Red
- Vintage Dublin
- Dark Color**
- *Musket Brown
- *Black
- Cedar Colors**
- American Walnut
- Cape Cod Grey
- Glacier Blue
- Natural Cedar
- Timberstone
- Woodland Green
- Solar Defense® Reflective Technology™**
- Alpine Forest
- Brandy Wood
- Deep Cavern
- Natural Slate
- Newport Bay
- Red Brick
- Rock Harbor
- Whispering Timber
- Woodland Retreat

MVJ071
All Purpose J-Channel - 7/8"
1" Face

- Length: 12' 6"
- 40 Pcs./Ctn.
- 48 Lbs./Ctn.

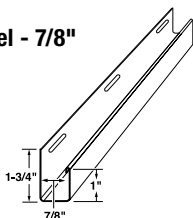

- White
- Light Colors**
- Almond
- Cameo
- Classic Cream
- Colonial Yellow
- Desert Sand
- Linen
- Sage
- Sandtone
- Silver Grey
- Tuscan Olive
- Victorian Grey
- Wicker
- Classic Colors**
- Corn Silk
- Everest
- Harbor Grey
- Pebblestone Clay
- Scottish Thistle
- Deep Colors**
- Autumn Harvest
- Deep Granite
- English Wedgewood
- Lakeshore Fern
- Misty Shadow
- Montana Suede
- Portsmouth Blue
- Quiet Willow
- Rugged Canyon
- Russet Red
- Terra Cotta
- Cedar Colors**
- American Walnut
- Cape Cod Grey
- Glacier Blue
- Natural Cedar
- Timberstone
- Woodland Green
- Solar Defense® Reflective Technology™**
- Alpine Forest
- Brandy Wood
- Deep Cavern
- Natural Slate
- Newport Bay
- Red Brick
- Rock Harbor
- Whispering Timber
- Woodland Retreat



J-Channel options

* Musket Brown and Black color is not warranted for sidewall use.

Universal Vinyl Siding Accessories

Product Code/Description

MVJ125

All Purpose J-Channel - 1-1/4" 1" Face

- Length: 12' 6"
- 20 Pcs./Ctn.
- 53 Lbs./Ctn.

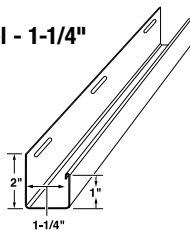

Color Availability

White

Light Colors

Almond
Cameo
Classic Cream
Desert Sand
Linen
Sage
Sandtone
Silver Grey
Victorian Grey
Wicker

Classic Colors

Corn Silk

Everest

Harbor Grey
Pebblestone Clay
Scottish Thistle

Deep Colors

Autumn Harvest
English Wedgewood
Deep Granite
Misty Shadow
Montana Suede
Quiet Willow
Rugged Canyon
Russet Red

MVFJ0341

Flexible J-Channel - 1"

- Length: 12' 6"
- 20 Pcs./Ctn.
- 66 Lbs./Ctn.
- Throat width: 13/16"

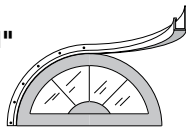

White

Light Colors

Pebblestone Clay

Universal Vinyl Siding Accessories

 Product Code/Description

 Color Availability

SCMNT126

Snap-In Crown Mount

- Length: 12' 6"
- 40 Pcs./Ctn.
- 46 Lbs./Ctn.

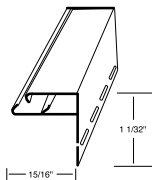

White

SCROWN126

Snap-In Crown 3" Crown

- Length: 12' 6"
- 20 Pcs./Ctn.
- 55 Lbs./Ctn.

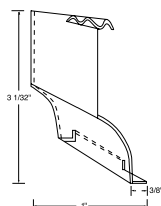

White

Light Colors

Cameo
Desert Sand
Wicker

Classic Color

Pebblestone Clay

Universal Vinyl Siding Accessories

Product Code/Description

Color Availability

MFT

Finish Trim

- Length: 12' 6"
- 40 Pcs./Ctn.
- 46 Lbs./Ctn.

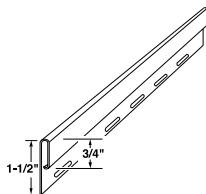

White

Light Colors

- Almond
- Cameo
- Classic Cream
- Colonial Yellow
- Desert Sand
- Linen
- Sage
- Sandtone
- Silver Grey
- Tuscan Olive
- Victorian Grey
- Wicker

- Misty Shadow
- Modern Iron
- Montana Suede
- Portsmouth Blue
- Quiet Willow
- Rugged Canyon
- Russet Red
- Vintage Dublin

Cedar Colors

- American Walnut
- Cape Cod Grey
- Glacier Blue
- Natural Cedar
- Timberstone
- Woodland Green

Classic Colors

- Corn Silk
- Everest
- Harbor Grey
- Pebblestone Clay
- Scottish Thistle

Solar Defense®

- Reflective Technology™**
- Alpine Forest
- Brandy Wood
- Deep Cavern
- Natural Slate
- Newport Bay
- Red Brick
- Rock Harbor
- Whispering Timber
- Woodland Retreat

Deep Colors

- Autumn Harvest
- Bayou
- Brunswick
- Deep Granite
- English Wedgewood
- Lakeshore Fern

MVDFT

Double Finish Trim

- Length: 12' 6"
- 20 Pcs./Ctn.
- 31 Lbs./Ctn.

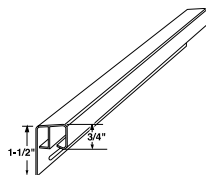

White

Light Colors

- Almond
- Cameo
- Classic Cream
- Colonial Yellow
- Desert Sand
- Linen
- Sage
- Sandtone
- Silver Grey
- Tuscan Olive

- Victorian Grey
- Wicker

Classic Colors

- Everest
- Harbor Grey
- Pebblestone Clay
- Scottish Thistle

Deep Colors

- Deep Granite
- Misty Shadow
- Rugged Canyon

WCT06

2-1/2" Wide Window Casing Trim - 3/4"

- Length: 12' 6"
- 20 Pcs./Ctn.
- 55 Lbs./Ctn.

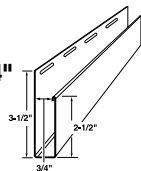

White

Light Colors

- Cameo
- Desert Sand
- Wicker

Classic Color

- Pebblestone Clay

WCT12

2-1/2" Wide Window Casing Trim - 1-1/4"

- Length: 12' 6"
- 20 Pcs./Ctn.
- 66 Lbs./Ctn.

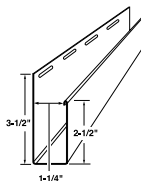

White

Ventura® Hidden Vent Soffit

Product Code/Description

HVS10V

Ventura® Triple 3 1/3" Hidden Vent Soffit

- Nominal Thickness: .044
- Finish: Matte
- 9.19 Sq. In. N.F.A./Sq. Ft.
- Length: 12'
- 20 Pcs./Ctn.
- 2 Sqs./Ctn.
- 122 Lbs./Ctn.

(Not warranted for sidewall use.)

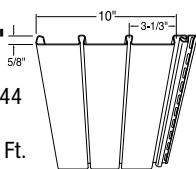

Color Availability

White

Light Colors

Almond
Cameo
Classic Cream
Desert Sand
Linen
Sandtone
Silver Grey
Victorian Grey
Wicker

Classic Colors

Harbor Grey
Pebblestone Clay

Deep Colors

Autumn Harvest
Deep Granite

English Wedgewood
Misty Shadow
Montana Suede
Rugged Canyon
Russet Red

Dark Color

Musket Brown

HVS10N

Ventura® Triple 3-1/3" Non-Ventilated Soffit/Wainscot

- Nominal Thickness: .044
- Finish: Matte
- Length: 12'
- 20 Pcs./Ctn.
- 2 Sqs./Ctn.
- 121 Lbs./Ctn.

(* Musket Brown color not warranted for sidewall use.)

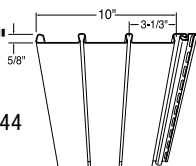

White

Light Colors

Almond
Cameo
Classic Cream
Desert Sand
Linen
Sandtone
Silver Grey
Victorian Grey
Wicker

Classic Colors

Harbor Grey
Pebblestone Clay

Deep Color

Autumn Harvest
Deep Granite

English Wedgewood
Misty Shadow
Montana Suede
Rugged Canyon
Russet Red

Dark Color

Musket Brown

**Soffit
options**



**Vertical siding
options**

**Installing
vinyl soffits**



Pro-Bead® Vinyl Soffit/ Wainscot and Accessories

Product Code/Description

Color Availability

PBS80N

Pro-Bead® 8" Non-Ventilated Soffit/Wainscot

- Nominal Thickness: .040
- Finish: Matte
- Length: 12' 6"
- 24 Pcs./Ctn.
- 2 Sqs./Ctn.
- 116 Lbs./Ctn.

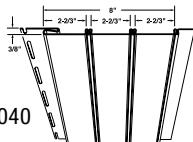

White

Light Colors

Cameo
Classic Cream
Desert Sand
Sandtone
Victorian Grey
Wicker

Classic Color

Pebblestone Clay

PBS80V

Pro-Bead® 8" Ventilated Soffit

- Nominal Thickness: .040
- Finish: Matte
- 1.54 Sq. In. N.F.A./Sq. Ft.
- Length: 12' 6"
- 24 Pcs./Ctn.
- 2 Sqs./Ctn.
- 116 Lbs./Ctn.

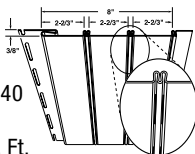

White

Light Colors

Cameo
Classic Cream
Desert Sand
Sandtone
Victorian Grey
Wicker

Classic Color

Pebblestone Clay

(Not warranted for sidewall use.)

PBSJ03

Pro-Bead® J-Channel - 3/8"

- Length: 12' 6"
- 24 Pcs./Ctn.
- 300 Ft./Ctn.
- 39 Lbs./Ctn.

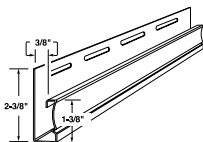

White

Light Colors

Cameo
Classic Cream
Desert Sand
Sandtone
Victorian Grey
Wicker

Classic Color

Pebblestone Clay



**Installing porch
ceilings/beaded
soffit**

Pro-Select® Vinyl Soffit

Product Code/Description

PSS10N

Pro-Select® Double 5" Premium Non-Ventilated Panel

- Nominal Thickness: .046
- Finish: Brushed
- Length: 12'
- 20 Pcs./Ctn.
- 2 Sqs./Ctn.
- 107 Lbs./Ctn.

(* Montana Suede and Musket Brown colors not warranted for sidewall use.)

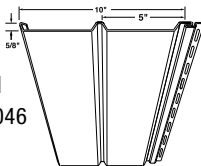

Color Availability

White

Light Colors

Almond
Cameo
Desert Sand
Linen
Sandtone
Victorian Grey
Wicker

Classic Colors

Harbor Grey
Pebblestone Clay
Scottish Thistle

Dark Color

*Musket Brown

Deep Color

*Montana Suede

Cedar Colors

American Walnut
Glacier Blue
Natural Cedar
Timberstone

PSS10V

Pro-Select® Double 5" Premium Ventilated Panel

- Nominal Thickness: .046
- Finish: Brushed
- 7.53 Sq. In. N.F.A./Sq. Ft.
- Length: 12'
- 20 Pcs./Ctn.
- 2 Sqs./Ctn.
- 104 Lbs./Ctn.

(Not warranted for sidewall use.)

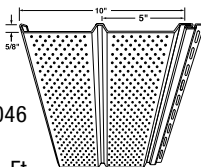

White

Light Colors

Almond
Cameo
Desert Sand
Linen
Sandtone
Victorian Grey
Wicker

Classic Colors

Harbor Grey
Pebblestone Clay
Scottish Thistle

Dark Color

Musket Brown

Deep Color

Montana Suede

Cedar Colors

American Walnut
Glacier Blue
Natural Cedar
Timberstone

Pro-Tech® Plus Vinyl Soffit

Product Code/Description

PTS12N

**Pro-Tech® Plus
Triple 4"**
Non-Ventilated Panel

- Nominal Thickness: .040
- Finish: Matte
- Length: 12'
- 16 Pcs./Ctn.
- 1.92 Sqs./Ctn.
- 90 Lbs./Ctn.

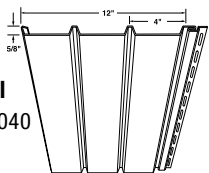

(*Black and Musket Brown color not warranted for sidewall use.)

Color Availability

White

Light Colors

Almond
Cameo
Classic Cream
Desert Sand
Linen
Sandtone
Silver Grey
Victorian Grey
Wicker

Classic Colors

Everest
Harbor Grey
Pebblestone Clay

Dark Colors

*Musket Brown
*Black

PTS12V

**Pro-Tech® Plus
Triple 4"**
Ventilated* Panel

- Nominal Thickness: .040
- Finish: Matte
- 5.87 Sq. In. N.F.A./Sq. Ft.
- Length: 12'
- 16 Pcs./Ctn.
- 1.92 Sqs./Ctn.
- 88 Lbs./Ctn.

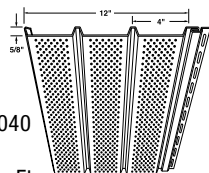

(*Not warranted for sidewall use.)

White

Light Colors

Almond
Cameo
Classic Cream
Desert Sand
Linen
Sandtone
Silver Grey
Victorian Grey
Wicker

Classic Colors

Everest
Harbor Grey
Pebblestone Clay

Dark Colors

Musket Brown
Black

PTS12CV

**Pro-Tech® Plus
Triple 4"**
Center Ventilated* Panel

- Nominal Thickness: .040
- Finish: Matte
- 1.96 Sq. In. N.F.A./Sq. Ft.
- Length: 12'
- 16 Pcs./Ctn.
- 1.92 Sqs./Ctn.
- 89 Lbs./Ctn.

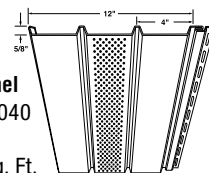

(*Not warranted for sidewall use.)

White

Pro-Tech® Plus Vinyl Soffit

Product Code/Description

PTS10N

Pro-Tech® Plus Double 5" Non-Ventilated Panel

- Nominal Thickness: .042
- Finish: Matte
- Length: 12'
- 20 Pcs./Ctn.
- 2 Sqs./Ctn.
- 94 Lbs./Ctn.

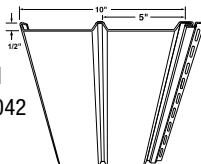

(Pro-Tech D5 not warranted for sidewall use.)

Color Availability

White

Light Colors

Almond
Cameo
Classic Cream
Desert Sand
Linen
Sandtone
Silver Grey
Victorian Grey
Wicker

Classic Colors

Everest
Harbor Grey
Pebblestone Clay

PTS10V

Pro-Tech® Plus Double 5" Ventilated Panel

- Nominal Thickness: .042
- Finish: Matte
- 7.53 Sq. In. N.F.A./Sq. Ft.
- Length: 12'
- 20 Pcs./Ctn.
- 2 Sqs./Ctn.
- 91 Lbs./Ctn.

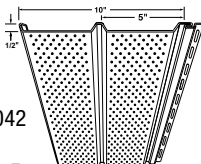

(Not warranted for sidewall use.)

White

Light Colors

Almond
Cameo
Classic Cream
Desert Sand
Linen
Sandtone
Silver Grey
Victorian Grey
Wicker

Classic Colors

Everest
Harbor Grey
Pebblestone Clay

Universal Vinyl Soffit

Product Code/Description

Color Availability

UVS12N

Universal Triple 4" Non-Ventilated Panel

- Nominal Thickness: .036
- Finish: Matte
- Length: 12'
- 16 Pcs./Ctn.
- 1.92 Sqs./Ctn.
- 80 Lbs./Ctn.

(Not warranted for sidewall use.)

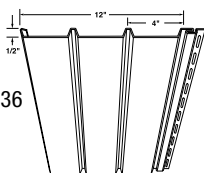

White

Light Colors

Almond
Cameo
Desert Sand
Linen
Sandtone
Wicker

Classic Color

Pebblestone Clay

Dark Color

Musket Brown

UVS12P

Universal Triple 4" Ventilated Panel

- Nominal Thickness: .036
- Finish: Matte
- 5.87 Sq. In. N.F.A./Sq. Ft.
- Length: 12'
- 16 Pcs./Ctn.
- 1.92 Sqs./Ctn.
- 75 Lbs./Ctn.

(Not warranted for sidewall use.)

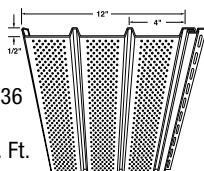

UVS12CP

Universal Triple 4" Center Ventilated Panel

- Nominal Thickness: .036
- Finish: Matte
- 1.96 Sq. In. N.F.A./Sq. Ft.
- Length: 12'
- 16 Pcs./Ctn.
- 1.92 Sqs./Ctn.
- 78 Lbs./Ctn.

(Not warranted for sidewall use.)

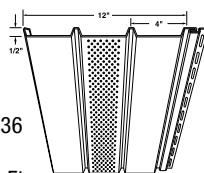

White

(Universal T4 not warranted for sidewall use.)

Universal Vinyl Soffit

Product Code/Description

TRMS10N

Universal Double 5" Non-Ventilated Panel

- Nominal Thickness: .040
- Finish: Woodgrain
- Length: 12'
- 20 Pcs./Ctn.
- 2 Sqs./Ctn.
- 90 Lbs./Ctn.

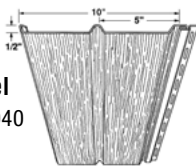

(Not warranted for sidewall use.)

Color Availability

White

Light Colors

Almond
Cameo
Desert Sand
Linen
Wicker

Classic Color

Pebblestone Clay

TRMS10V

Universal Double 5" Ventilated Panel

- Nominal Thickness: .040
- Finish: Woodgrain
- 7.53 Sq. In. N.F.A./Sq. Ft.
- Length: 12'
- 20 Pcs./Ctn.
- 2 Sqs./Ctn.
- 87 Lbs./Ctn.

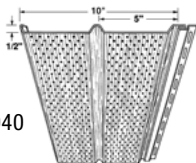

(Not warranted for sidewall use.)

(Universal D5 Soffit not warranted for sidewall use.)

Vinyl Soffit Accessories

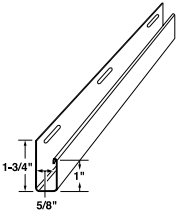
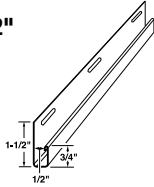
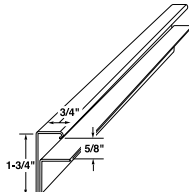
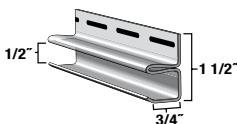
Product Code/Description	Color Availability			
MVJ051 All Purpose J-Channel - 5/8" 1" Face <ul style="list-style-type: none"> Length: 12' 6" 40 Pcs./Ctn. 45 Lbs./Ctn. 		White	English Wedgewood Lakeshore Fern Misty Shadow Modern Iron Montana Suede Portsmouth Blue Quiet Willow Rugged Canyon Russet Red Vintage Dublin	Newport Bay Red Brick Rock Harbor Whispering Timber Woodland Retreat
		Light Colors Almond Cameo Classic Cream Colonial Yellow Desert Sand Linen Sage Sandtone Silver Grey Tuscan Olive Victorian Grey Wicker	Dark Colors Black Musket Brown	Classic Colors Corn Silk Everest Harbor Grey Pebblestone Clay Scottish Thistle
MVJ04 Soffit J-Channel - 1/2" <ul style="list-style-type: none"> Length: 12' 6" 40 Pcs./Ctn. 41 Lbs./Ctn. 		White	Light Colors Almond Cameo Desert Sand Linen Sandtone Wicker	Classic Color Pebblestone Clay
		Dark Colors Musket Brown	White Light Colors Almond Cameo Desert Sand Sage Sandtone Wicker	Classic Color Pebblestone Clay
VFR05 5/8" "F" Channel <ul style="list-style-type: none"> Length: 12' 6" 24 Pcs./Ctn. 40 Lbs./Ctn. 		White	Light Colors Almond Cameo Desert Sand Sage Sandtone Wicker	Classic Color Pebblestone Clay
		Dark Colors Black Musket Brown	White Light Colors Almond Cameo Desert Sand Sage Sandtone Wicker	Classic Color Pebblestone Clay
MFCH04 1/2" "F" Channel <ul style="list-style-type: none"> Length: 12' 6" 40 Pcs./Ctn. 46 Lbs./Ctn. 		White	Light Colors Almond Cameo Desert Sand Sage Sandtone Wicker	Classic Color Pebblestone Clay
		Dark Colors Black Musket Brown	White Light Colors Almond Cameo Desert Sand Sage Sandtone Wicker	Classic Color Pebblestone Clay

Vinyl Soffit Accessories

 Product Code/Description

 Color Availability

MVTC05

"T" Channel - 5/8"

- Length: 12' 6"
- 12 Pcs./Ctn.
- 33 Lbs./Ctn.

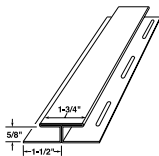

White

Classic Color
 Pebblestone Clay

SCMNT126

Snap-In Crown Mount

- Length: 12' 6"
- 40 Pcs./Ctn.
- 46 Lbs./Ctn.

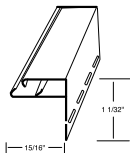

White

SCROWN126

Snap-In 3" Crown

- Length: 12' 6"
- 20 Pcs./Ctn.
- 55 Lbs./Ctn.

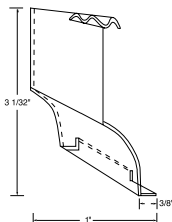

White

Light Colors
 Cameo
 Desert Sand
 Wicker

Classic Color
 Pebblestone Clay

Notes:

Shutters

Standard 12" & 15" Raised Panel

Product Code/Description

VINRP12

Standard Raised Panel Shutters

- 12" Wide (Nominal)
- High Density Copolymer
- Baked-on Acrylic Finish
- 1 Pair/Ctn.

Product Code	Length	Lbs./Ctn.
VINRP1227	27"	6 Lbs./Ctn.
VINRP1231	31"	7 Lbs./Ctn.
VINRP1235	35"	8 Lbs./Ctn.
VINRP1239	39"	8 Lbs./Ctn.
VINRP1243	43"	9 Lbs./Ctn.
VINRP1247	47"	10 Lbs./Ctn.
VINRP1251	51"	11 Lbs./Ctn.
VINRP1255	55"	12 Lbs./Ctn.
VINRP1259	59"	12 Lbs./Ctn.
VINRP1263	63"	13 Lbs./Ctn.
VINRP1267	67"	13 Lbs./Ctn.
VINRP1271	71"	15 Lbs./Ctn.

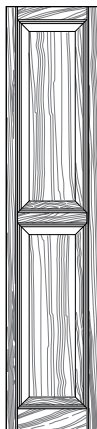

Regular Style

Color Availability

11	White
33	Black
99	Blackwatch Green
41	Blue
59	Brown
BLU	Coastal Blue
IJ	Dark Berry
95	Dark Navy
56	Dark Spruce
55	Green
16	Grey
52	Pebblestone Clay
PE	Peppercorn
38	Red
CRM	Sand Dollar
93	Spanish Moss
SL	Terra Brown
SK	Vineyard Red
58	Winestone

SHERWIN-WILLIAMS®

EGF	Evergreen Fog, SW 9130
GAF	Gale Force, SW 7605
URB	Urbane Bronze, SW 7048

VINRP15

Standard Raised Panel Shutters

- 15" Wide (Nominal)
- High Density Copolymer
- Baked-on Acrylic Finish
- 1 Pair/Ctn.

Product Code	Length	Lbs./Ctn.
VINRP1531	31"	6 Lbs./Ctn.
VINRP1535	35"	7 Lbs./Ctn.
VINRP1539	39"	8 Lbs./Ctn.
VINRP1543	43"	8 Lbs./Ctn.
VINRP1547	47"	9 Lbs./Ctn.
VINRP1551	51"	10 Lbs./Ctn.
VINRP1555	55"	10 Lbs./Ctn.
VINRP1559	59"	11 Lbs./Ctn.
VINRP1563	63"	12 Lbs./Ctn.
VINRP1567	67"	13 Lbs./Ctn.
VINRP1567C	67"	13 Lbs./Ctn.
VINRP1571	71"	13 Lbs./Ctn.
VINRP1575	75"	14 Lbs./Ctn.
VINRP1581	81"	15 Lbs./Ctn.

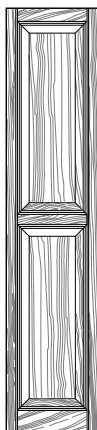

Regular Style

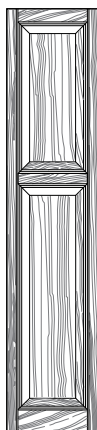
Cottage Style
(67" Length only)

Notes: All shutter dimensions are nominal. All louvered and raised panel shutter cartons include 3" painted steel mounting screws and shutter plugs.

Sherwin-Williams® is a registered trademark of SWIMC LLC.



**Installing
Shutters**

Shutters

Standard 12" & 15" Louvered

Product Code/Description

VINLV12

Standard Open Louvered Shutters

- 12" Wide (Nominal)
- High Density Copolymer
- Baked-on Acrylic Finish
- 1 Pair/Ctn.

Product Code	Length	Lbs./Ctn.
VINLV1255	55"	12 Lbs./Ctn.
VINLV1259	59"	12 Lbs./Ctn.



Regular Style

Color Availability

11	White
33	Black
99	Blackwatch Green
41	Blue
59	Brown
BLU	Coastal Blue
IJ	Dark Berry
95	Dark Navy
56	Dark Spruce
55	Green
16	Grey
52	Pebblestone Clay
PE	Peppercorn
38	Red
CRM	Sand Dollar
93	Spanish Moss
SL	Terra Brown
SK	Vineyard Red
58	Winstone

SHERWIN-WILLIAMS®

EGF	Evergreen Fog, SW 9130
GAF	Gale Force, SW 7605
URB	Urbane Bronze, SW 7048

VINLV15

Standard Open Louvered Shutters

- 15" Wide (Nominal)
- High Density Copolymer
- Baked-on Acrylic Finish
- 1 Pair/Ctn.

Product Code	Length	Lbs./Ctn.
VINLV1525	25"	5 Lbs./Ctn.
VINLV1531	31"	6 Lbs./Ctn.
VINLV1535	35"	7 Lbs./Ctn.
VINLV1539	39"	7 Lbs./Ctn.
VINLV1543	43"	8 Lbs./Ctn.
VINLV1547	47"	8 Lbs./Ctn.
VINLV1551	51"	9 Lbs./Ctn.
VINLV1555	55"	11 Lbs./Ctn.
VINLV1559	59"	11 Lbs./Ctn.
VINLV1563	63"	11 Lbs./Ctn.
VINLV1567	67"	12 Lbs./Ctn.
VINLV1567C	67"	12 Lbs./Ctn.
VINLV1571	71"	12 Lbs./Ctn.
VINLV1575	75"	14 Lbs./Ctn.
VINLV1581	81"	14 Lbs./Ctn.



Regular Style

Cottage Style
(67" Length only)

Notes: All shutter dimensions are nominal. All louvered and raised panel shutter cartons include 3" painted steel mounting screws and shutter plugs.

Sherwin-Williams® is a registered trademark of SWIMC LLC.

Shutters

Standard 11" & 12" Board+Batten

Product Code/Description

VIN3C11 & VIN3012

Standard Board+Batten 3-Board Shutters

- 11"-12" Wide (Nominal)
- High Density Copolymer
- Baked-on Acrylic Finish
- 1 Pair/Ctn.

CLOSED

Product Code	Length	Lbs./Ctn.
VIN3C1131	11"x31"	4.5 Lbs./Ctn.
VIN3C1135	11"x35"	5 Lbs./Ctn.
VIN3C1139	11"x39"	5 Lbs./Ctn.
VIN3C1143	11"x43"	5.5 Lbs./Ctn.
VIN3C1147	11"x47"	6 Lbs./Ctn.
VIN3C1151	11"x51"	6 Lbs./Ctn.
VIN3C1155	11"x55"	7 Lbs./Ctn.
VIN3C1159	11"x59"	7.5 Lbs./Ctn.
VIN3C1163	11"x63"	8 Lbs./Ctn.
VIN3C1167	11"x67"	8.5 Lbs./Ctn.
VIN3C1171	11"x71"	9 Lbs./Ctn.
VIN3C1175	11"x75"	9 Lbs./Ctn.
VIN3C1181	11"x81"	10 Lbs./Ctn.

OPEN

Product Code	Length	Lbs./Ctn.
VIN301231	12"x31"	4.5 Lbs./Ctn.
VIN301235	12"x35"	5 Lbs./Ctn.
VIN301239	12"x39"	5 Lbs./Ctn.
VIN301243	12"x43"	6 Lbs./Ctn.
VIN301247	12"x47"	6 Lbs./Ctn.
VIN301251	12"x51"	6.5 Lbs./Ctn.
VIN301255	12"x55"	7.5 Lbs./Ctn.
VIN301259	12"x59"	8 Lbs./Ctn.
VIN301263	12"x63"	8 Lbs./Ctn.
VIN301267	12"x67"	8.5 Lbs./Ctn.
VIN301271	12"x71"	9 Lbs./Ctn.
VIN301275	12"x75"	9.5 Lbs./Ctn.
VIN301281	12"x81"	10 Lbs./Ctn.



Closed Style



Open Style

Color Availability

11	White
33	Black
99	Blackwatch Green
41	Blue
59	Brown
BLU	Coastal Blue
IJ	Dark Berry
95	Dark Navy
56	Dark Spruce
55	Green
16	Grey
52	Pebblestone Clay
PE	Peppercorn
38	Red
CRM	Sand Dollar
93	Spanish Moss
SL	Terra Brown
SK	Vineyard Red
58	Winestone

SHERWIN-WILLIAMS®

EGF	Evergreen Fog, SW 9130
GAF	Gale Force, SW 7605
URB	Urbane Bronze, SW 7048

Notes: All shutter dimensions are nominal. Board+Batten shutter cartons include steel mounting screws.

Lengths 51" and smaller have 2 horizontal boards.

Lengths 55" and longer have 3 horizontal boards.

Sherwin-Williams® is a registered trademark of SWIMC LLC.



**Installing
Shutters**

Shutters

Standard 15" & 16" Board+Batten

Product Code/Description

VIN4C15 & VIN4016

Standard Board+Batten 4-Board Shutters

- 15"-16" Wide (Nominal)
- High Density Copolymer
- Baked-on Acrylic Finish
- 1 Pair/Ctn.

CLOSED

Product Code	Length	Lbs./Ctn.
VIN4C1531	15"x31"	6 Lbs./Ctn.
VIN4C1535	15"x35"	6.5 Lbs./Ctn.
VIN4C1539	15"x39"	7 Lbs./Ctn.
VIN4C1543	15"x43"	7.5 Lbs./Ctn.
VIN4C1547	15"x47"	8 Lbs./Ctn.
VIN4C1551	15"x51"	8.5 Lbs./Ctn.
VIN4C1555	15"x55"	10 Lbs./Ctn.
VIN4C1559	15"x59"	10 Lbs./Ctn.
VIN4C1563	15"x63"	10.5 Lbs./Ctn.
VIN4C1567	15"x67"	11 Lbs./Ctn.
VIN4C1571	15"x71"	11.5 Lbs./Ctn.
VIN4C1575	15"x75"	12 Lbs./Ctn.
VIN4C1581	15"x81"	13 Lbs./Ctn.

OPEN

Product Code	Length	Lbs./Ctn.
VIN401631	16"x31"	6 Lbs./Ctn.
VIN401635	16"x35"	6.5 Lbs./Ctn.
VIN401639	16"x39"	7 Lbs./Ctn.
VIN401643	16"x43"	7.5 Lbs./Ctn.
VIN401647	16"x47"	8 Lbs./Ctn.
VIN401651	16"x51"	8.5 Lbs./Ctn.
VIN401655	16"x55"	10 Lbs./Ctn.
VIN401659	16"x59"	10.5 Lbs./Ctn.
VIN401663	16"x63"	11 Lbs./Ctn.
VIN401667	16"x67"	11.5 Lbs./Ctn.
VIN401671	16"x71"	12 Lbs./Ctn.
VIN401675	16"x75"	12.5 Lbs./Ctn.
VIN401681	16"x81"	13 Lbs./Ctn.

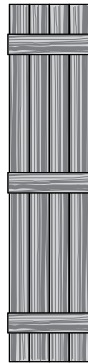

Closed Style



Open Style

Color Availability

11	White
33	Black
99	Blackwatch Green
41	Blue
59	Brown
BLU	Coastal Blue
IJ	Dark Berry
95	Dark Navy
56	Dark Spruce
55	Green
16	Grey
52	Pebblestone Clay
PE	Peppercorn
38	Red
CRM	Sand Dollar
93	Spanish Moss
SL	Terra Brown
SK	Vineyard Red
58	Winestone

SHERWIN-WILLIAMS®

EGF	Evergreen Fog, SW 9130
GAF	Gale Force, SW 7605
URB	Urbane Bronze, SW 7048

Notes: All shutter dimensions are nominal. Board+Batten shutter cartons include steel mounting screws.

Lengths 51" and smaller have 2 horizontal boards.

Lengths 55" and longer have 3 horizontal boards.

The following lengths of VIN4C are molded panels - 47", 55", 59", 63", and 71".

Sherwin-Williams® is a registered trademark of SWMC LLC.



**Installing
Shutters**

Shutters

Arched Top 14" Board+Batten

Product Code/Description

BBARCH

Arch Top Board+Batten Shutter

- 14" Wide (Nominal)
- High Density Copolymer
- Baked-on Acrylic Finish
- 1 Pair/Ctn.

Product Code	Length	Lbs./Ctn.
BBARCH41	41"	7 Lbs./Ctn.
BBARCH43	43"	7.5 Lbs./Ctn.
BBARCH47	47"	8 Lbs./Ctn.
BBARCH57	57"	9.5 Lbs./Ctn.
BBARCH61	61"	10 Lbs./Ctn.
BBARCH65	65"	10.5 Lbs./Ctn.
BBARCH71	71"	11.5 Lbs./Ctn.
BBARCH73	73"	12 Lbs./Ctn.
BBARCH77	77"	12.5 Lbs./Ctn.
BBARCH85	85"	13 Lbs./Ctn.

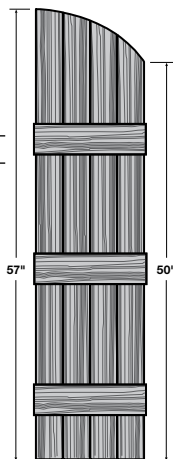

Color Availability

11	White
33	Black
99	Blackwatch Green
41	Blue
59	Brown
BLU	Coastal Blue
IJ	Dark Berry
95	Dark Navy
56	Dark Spruce
55	Green
16	Grey
52	Pebblestone Clay
PE	Peppercorn
38	Red
CRM	Sand Dollar
93	Spanish Moss
SL	Terra Brown
SK	Vineyard Red
58	Winestone

SHERWIN-WILLIAMS®

EGF	Evergreen Fog, SW 9130
GAF	Gale Force, SW 7605
URB	Urbane Bronze, SW 7048

Notes: All shutter dimensions are nominal. Board+Batten shutter cartons include steel mounting screws. The short side of shutter is 7" shorter than Product Code length.

Sherwin-Williams® is a registered trademark of SWIMC LLC.

Installing
Shutters



Shutters

Accessories

Product Code/Description

ARCH15RP

15" Raised Panel Arch Top

- 1 Pair/Ctn.
- 3 Lbs./Ctn.

* For standard shutters only

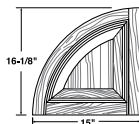

TRANRP15

15" Raised Panel Transom Top

- 1 Pair/Ctn.
- 3 Lbs./Ctn.

* For standard shutters only

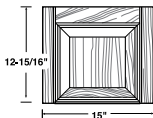

Notes: All shutter dimensions are nominal. All louvered and raised panel shutter cartons include 3" painted steel mounting screws and shutter plugs.
Not for use with custom shutters

ARCH15LV

15" Open Louvered Arch Top

- 1 Pair/Ctn.
- 3 Lbs./Ctn.

* For standard shutters only

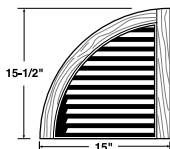

Color Availability

- 11 White
- 33 Black
- 99 Blackwatch Green
- 41 Blue
- 59 Brown
- BLU Coastal Blue
- IJ Dark Berry
- 95 Dark Navy
- 56 Dark Spruce
- 55 Green
- 16 Grey
- 52 Pebblestone Clay
- PE Peppercorn
- 38 Red
- CRM Sand Dollar
- 93 Spanish Moss
- SL Terra Brown
- SK Vineyard Red
- 58 Winestone

SHERWIN-WILLIAMS®

- EGF Evergreen Fog,
SW 9130
- GAF Gale Force,
SW 7605
- URB Urbane Bronze,
SW 7048



**Installing
Shutters**

Shutters

Accessories

Product Code/Description

Color Availability

SHUTTRPLUG

Fastener

- 1/4" x 2-5/8"
- 12 Pcs./Pkg.

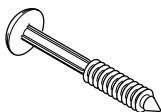

- 11 White
- 33 Black
- 99 Blackwatch Green
- 41 Blue
- 59 Brown
- BLU Coastal Blue
- IJ Dark Berry
- 95 Dark Navy
- 56 Dark Spruce
- 55 Green
- 16 Grey
- 52 Pebblestone Clay
- PE Peppercorn
- 38 Red
- CRM Sand Dollar
- 93 Spanish Moss
- SL Terra Brown
- SK Vineyard Red
- 58 Winestone

VINITT

Painted Steel Replacement Screws

- 3/16" x 3"
- 4 Pcs./Pkg.



- SHERWIN-WILLIAMS®**
- EGF Evergreen Fog, SW 9130
 - GAF Gale Force, SW 7605
 - URB Urbane Bronze, SW 7048

SHTCLP12

Shutter Clips and Anchors

- 12 Pc. = 1 Each
- 50 Each = 1 Ctn.

*For standard shutters only.



Mill Finish

SHOOK

Hooks and Hinges

Includes:

- (4) Hinges,
- (2) S-Hooks (right and left)
- (10) Screws

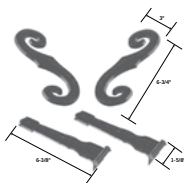

33 Black

Door Surround Systems

Product Code/Description

Color Availability

PEDIMENTST

Pediment Set

- Pediment Height: 12-3/4"
- Overall Height: 18-1/2"
- 1 Pc./Ctn.
- 8 Lbs./Ctn.

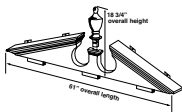

11 White (paintable)

MANTEL

Door Surround Mantel

- Length: 58"
- 1 Pc./Ctn.
- 7.41 Lbs./Ctn.

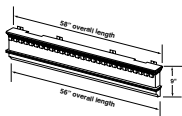

MANTELOVLY

Door Mantel Overlay

- Length: 10-1/2"
- 6 Pcs./Ctn.
- 6.24 Lbs./Ctn.

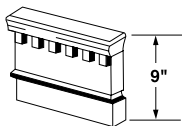

TOPCAP

Pilaster Cap

- 1 Pc./Ctn.
- .23 Lb./Ctn.

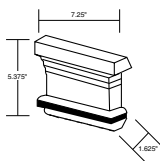

BASECAP

Pilaster Base

- 1 Pc./Ctn.
- .56 Lb./Ctn.

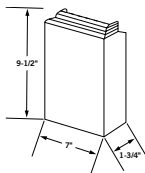

**Installing Door
Surrounds**

Door Surround Systems

 Product Code/Description

 Color Availability

PILASTER96

96" Pilaster Set

- 2 Pilasters
- 6 Mounting Clips
- 2 Pilaster Caps
- 2 Pilaster Bases
- Width: 7-1/2"
- Height: 96"
- 1 Pair/Ctn.
- 15.49 Lbs./Ctn.

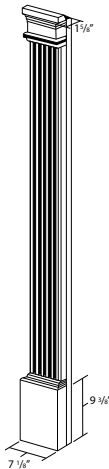
 11 White (paintable)

PILASTER144

144" Pilaster Set

- 2 Pilasters
- 6 Mounting Clips
- 2 Pilaster Caps
- 2 Pilaster Bases
- Width: 7-1/2"
- Height: 144"
- 1 Pair/Ctn.
- 19.71 Lbs./Ctn.

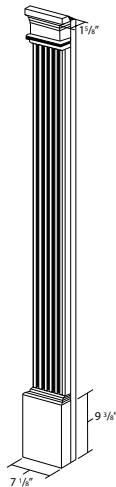

Mantel Systems

Product Code/Description	Color Availability
--------------------------	--------------------

MANTEL120

04 White

120" Mantel System

Mantel:

- Face Height: 7-3/8"
- Length: 120"

Plain Cover Strip:

- Height: 1"
- Length: 120"
- Thickness: .139

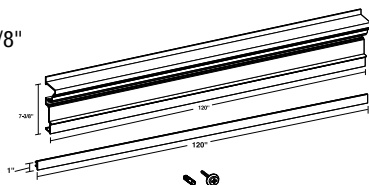

Mantel System Includes:

- 1 – Mantel (120")
- 1 – Plain Cover Strip (120")
- 16 – (8) Anchors and (8) Screw/Washers
- 1 Mantel System/Ctn.
- 15.25 Lbs./Ctn.

DENTILSTP

60" Dentil Strip

- Height: 1"
- Length: 60"
- 2 Pcs./Ctn.
- 2.4 Lbs./Ctn.

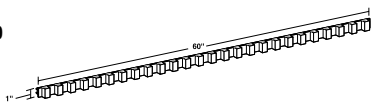

KEYSTN

Keystone for 120" Mantel System

- Height: 7-1/2"
- Top Width: 7"
- Bottom Length: 4-3/4"
- 1 Pc./Ctn.
- 1.26 Lb./Ctn.

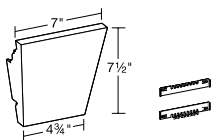

(includes mounting hardware)

Installing 10
foot mantel



Mantel Systems

Product Code/Description

Color Availability

SDGENDCAP

Siding Endcaps for 120" Mantel System

- Height: 7-3/8"
- Width: 3-1/4"
- 2 Pcs./Ctn.
- 2.98 Lbs./Ctn.

(includes adhesive)

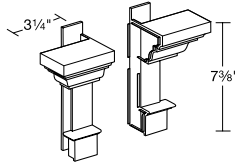

04 White

BRKENDCAP

Brick Endcaps for 120" Mantel System

- Height: 7-3/8"
- Width: 3-1/4"
- 2 Pcs./Ctn.
- 3.06 Lbs./Ctn.

(includes adhesive)

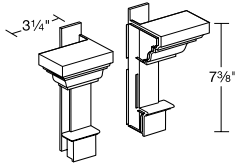

Window Mantels

Product Code/Description

Color Availability

36" 40" 44" Window Mantel

11 White (paintable)

- Height: 7-1/4"
- 1 Pc./Ctn.

Product Code	Length	Lbs./Ctn.
PLWINMTL36	36"	6 Lbs./Ctn.
PLWINMTL40	40"	6.54 Lbs./Ctn.
PLWINMTL44	44"	7 Lbs./Ctn.

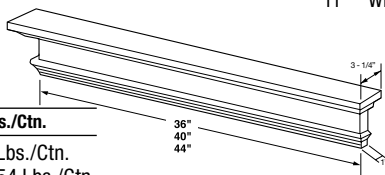

36" 40" 44" Window Mantel with Dentil Trim

- Height: 7-1/4"
- 1 Pc./Ctn.

Product Code	Length	Lbs./Ctn.
DTWINMTL36	36"	6 Lbs./Ctn.
DTWINMTL40	40"	6.54 Lbs./Ctn.
DTWINMTL44	44"	7 Lbs./Ctn.

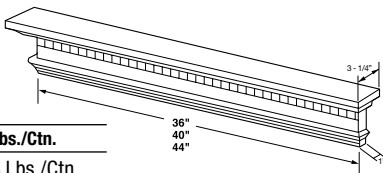

PLY GEM SHUTTERS & ACCESSORIES

KEYSTONE

Keystone for Window Mantel

- Height: 8-3/4"
- Length: 7-3/4"
- 1 Pc./Ctn.
- 1.43 Lb./Ctn.

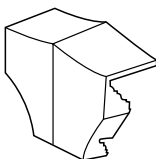

ENDCAP

Endcap for Window Mantel

- 1 Pc./Ctn.
- .82 Lb./Ctn.

(includes adhesive)

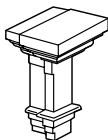

Mounting Blocks

Product Code/Description

UNIBLOCK

J-Block® Square Mounting Block

Mounting Surface:

- 5" x 6"

Trim Ring Dimensions:

- 7-1/4" x 8-1/8"

J-Channel I.D.:

- 1/2" adjusts to 1-1/4"

Knockouts:

- Round: 4" Diameter
- Rectangle: 2-3/8" x 3-3/4"
- 10 Pcs./Ctn.
- 6 Lbs./Ctn.

Uses: Light Fixtures, Electrical Receptacles, Water Faucets

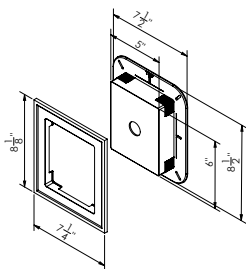

Color Availability

Available in more than 150 colors to match or coordinate with leading siding manufacturer's colors, including Paintable White (11).

UNIBLOCKSC

J-Block® Square Mounting Block Scroll 4" Knockout

Mounting Surface:

- 5" x 6"

Trim Ring Dimensions:

- 7-1/4" x 8-1/8"

J-Channel I.D.:

- 1/2" adjusts to 1-1/4"

Knockouts:

- Round: 4" Diameter
- Rectangle: 2-3/8" x 3-3/4"
- 10 Pcs./Ctn.
- 6 Lbs./Ctn.

Uses: Light Fixtures, Electrical Receptacles, Water Faucets

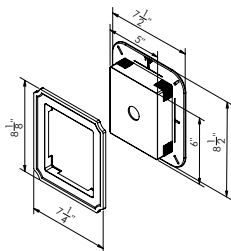

Installing
mounting blocks
and fixture vents

Mounting Blocks

Product Code/Description

Color Availability

MBLOCK

Mini J-Block® Mounting Block

Mounting Surface:

- 6" x 4-3/8"

Flange Dimensions:

- 6 7/8" x 5-1/4"

J-Channel I.D.:

- 3/4" adjusts to 1-1/4"

Knockouts:

- Round: 1-1/8" Diameter
- Rectangle: 2-3/8" x 3-3/4"

- 10 Pcs./Ctn.

- 3 Lbs./Ctn.

Uses: Doorbell, Electrical Outlet

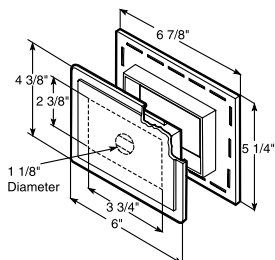

Available in more than 150 colors to match or coordinate with leading siding manufacturer's colors, including Paintable White (11).

MBLOCKR

Split Recessed J-Block® Mounting Block

Mounting Surface:

- 3-5/8" x 5-1/4"

Trim Ring Dimensions:

- 5-5/8" x 7-3/8"

J-Channel I.D.:

- 1/2" adjusts to 1-1/4"

Knockouts:

- Rectangle: 2-1/4" x 3-7/8"

- 10 Pcs./Ctn.

- 3.4 Lbs./Ctn.

Uses: Faucets, Electrical Outlet

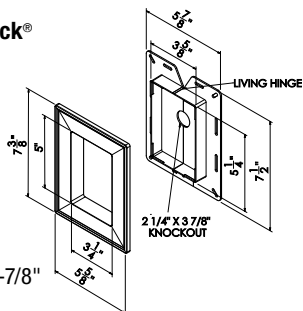

Mounting Blocks

Product Code/Description

EBLOCK

UL Electrical Block*

Mounting Surface:

- 5" x 6"

Projection:

- 2-1/8"

Trim Ring Dimensions:

- 7-1/8" x 8-1/8"

J-Channel I.D.:

- 1/2" adjusts to 1-1/4"
- 1 Pc./Ctn.
- 1 Lbs./Ctn.

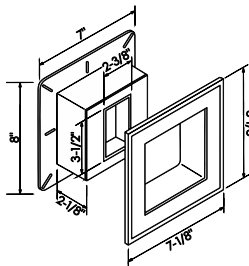

* Includes UL approved black electrical box

Color Availability

Available in more than 150 colors to match or coordinate with leading siding manufacturer's colors, including Paintable White (11).

JMBLOCK

Large J-Block® Mounting Block

Mounting Surface:

- 6" x 10-1/8"

Trim Ring Dimensions:

- 8-3/8" x 12-1/2"

J-Channel I.D.:

- 1/2" adjusts to 1-1/4"
- 5 Pcs./Ctn.
- 4 Lbs./Ctn.

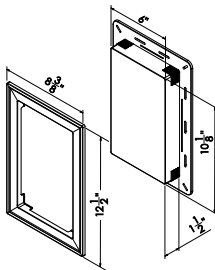

Uses: Light Fixtures, Mailbox, House Numbers
Can be used with insulated siding
Does not include electrical box

JMBLOCKSC

Large J-Block® Mounting Block with Scroll Cut Square

Mounting Surface:

- 6" x 10-1/8"

Trim Ring Dimensions:

- 8-3/8" x 12-1/2"

J-Channel I.D.:

- 1/2" adjusts to 1-1/4"
- 5 Pcs./Ctn.
- 4 Lbs./Ctn.

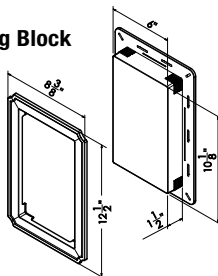

Uses: Light Fixtures, Mailbox, House Numbers
Can be used with insulated siding
Does not include electrical box

Mounting Blocks

Product Code/Description

Color Availability

JMEBLOCK

Large J-Block® Mounting Block with UL Electrical Box*

Mounting Surface:

- 6" x 10-1/8"
- Trim Ring Dimensions:
- 8-3/8" x 12-1/2"
- Adjusts 1/2" - 1-1/4"
- 4 Pcs./Ctn.
- 4.5 Lbs./Ctn.

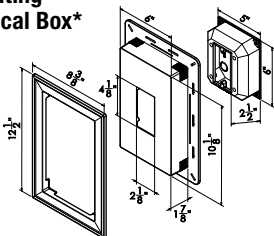

* Includes UL approved black electrical box

Available in more than 150 colors to match or coordinate with leading siding manufacturer's colors, including Paintable White (11).

JMEBLOCKSC

Large J-Block® Mounting Block with UL Electrical Box Scroll Cut*

Mounting Surface:

- 6" x 10-1/8"
- Trim Ring Dimensions:
- 8-3/8" x 12-1/2"
- Adjusts 1/2" - 1-1/4"
- 4 Pcs./Ctn.
- 4.5 Lbs./Ctn.

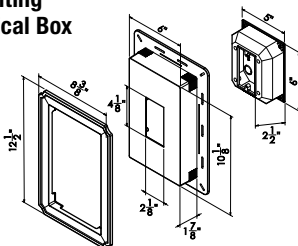

* Includes UL approved black electrical box

JMEOBLOCK

Large J-Block® Mounting Block with UL Electrical Box Offset*

Mounting Surface:

- 6" x 10-1/8"
- Trim Ring Dimensions:
- 8-3/8" x 12-1/2"
- Adjusts 1/2" - 1-1/4"
- 4 Pcs./Ctn.
- 4.5 Lbs./Ctn.

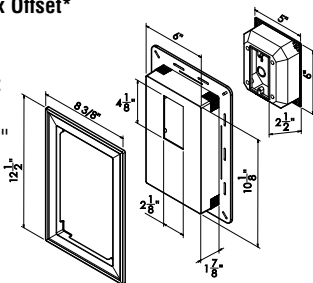

* Includes UL approved black electrical box

Mounting Blocks

Product Code/Description

Color Availability

JMEOBLOCKSC

Large J-Block® Mounting Block with UL Electrical Box Offset Scroll*

Mounting Surface:

- 6" x 10-1/8"

Trim Ring Dimensions:

- 8-3/8" x 12-1/2"

J-Channel I.D.:

- 1/2" adjusts to 1-1/4"
- 4 Pcs./Ctn.
- 4.5 Lbs./Ctn.

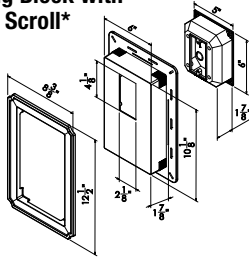

* Includes UL approved black electrical box

Available in more than 150 colors to match or coordinate with leading siding manufacturer's colors, including Paintable White (11).

UNIBLOCKXL

Large J-Block® Mounting Block

Mounting Surface:

- 9" x 16"

Trim Ring Dimensions:

- 11-3/4" x 18-3/4"

J-Channel I.D.:

- 1/2" adjusts to 1-1/4"

Knockouts:

- Round: 4" Diameter
- Rectangle: 2-3/8" x 3-3/4"
- 4 Pcs./Ctn.
- 5 Lbs./Ctn.

Uses: Light Fixtures, Mailbox, House Numbers

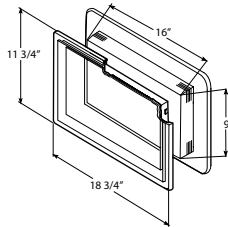

METERLG

Jumbo Meter Base J-Block®

Mounting Surface:

- 20" x 24"

Trim Ring Dimensions:

- 21-1/2" x 24-1/2"

J-Channel I.D.:

- 1/2" adjusts to 1-1/4"
- 1 Pcs./Ctn.
- 4 Lbs./Ctn.

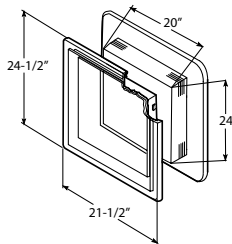

Mounting Blocks

Product Code/Description

METER

Meter Base J-Block®

Mounting Surface:

- 16-1/2" x 15-1/2"

Flange Dimensions:

- 18-1/2" x 16-3/4"

J-Channel I.D.:

- 1-1/4"
- 5 Pcs./Ctn.
- 10 Lbs./Ctn.

Uses: Hose Rack, Electric Meter Base

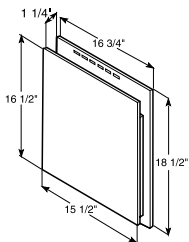

Color Availability

Available in more than 150 colors to match or coordinate with leading siding manufacturer's colors, including Paintable White (11).

E-Z Block® Surface Mounts

Product Code/Description

EZBLK040

Square Surface Mount (Double 4" or Double 5")

Surface Dimensions:

- 6-3/4" x 6-3/4"
- Projections: 3/4"

Knockouts:

- Round: 1" Diameter
- Rectangle: 2-3/8" x 3-3/4"

- 10 Pcs./Ctn.
- 4 Lbs./Ctn.

Uses: Light Fixtures, Electrical Receptacles, Water Faucets

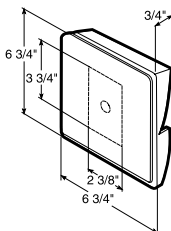

Color Availability

Available in more than 150 colors to match or coordinate with leading siding manufacturer's colors, including Paintable White (11).

EZBLK070

Square Surface Mount (Dutch Lap)

Surface Dimensions:

- 6-3/4" x 6-3/4"
- Projections: 3/4"

Knockouts:

- Round: 1" Diameter
- Rectangle: 2-3/8" x 3-3/4"

- 10 Pcs./Ctn.
- 4 Lbs./Ctn.

Uses: Light Fixtures, Electrical Outlets, Water Faucets

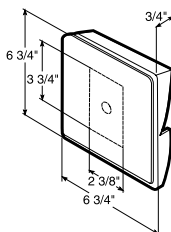

EZBLK080

Octagon Surface Mount (Double 4" or Double 5")

Surface Dimensions:

- 6-3/4" x 6-3/4"
- Projections: 3/4"

Knockouts:

- Round: 1" Diameter
- Rectangle: 2-3/8" x 3-3/4"

- 10 Pcs./Ctn.
- 3.34 Lbs./Ctn.

Uses: Light Fixtures, Electrical Outlets, Water Faucets

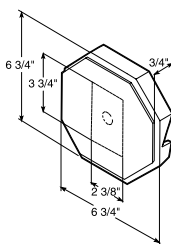

Utility Vents

Product Code/Description

DRYERHOOD

4" Hooded Exhaust Vent System

Flange Dimensions:

- 6-5/8" x 6-5/8"

Hood Dimensions:

- 6-7/8" x 6-7/8"

- Neutral Base

J-Channel I.D.:

- 3/4" adjusts to 1-1/4"

- Tube Length: 10"

- Tube Diameter: 4"

- 1 System/Ctn.

- 1 Lb./Ctn.
-

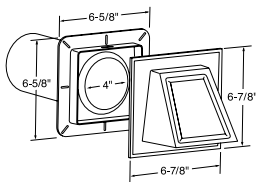

Color Availability

Available in more than 150 colors to match or coordinate with leading siding manufacturer's colors, including Paintable White (11).

DRYERHOOD6

6" Hooded Exhaust Vent System

Flange Dimensions:

- 9" x 9"

Hood Dimensions:

- 8-1/2" x 8-1/2"

J-Channel I.D.:

- 3/4" adjusts to 1-1/4"

- Tube Length: 10"

- Tube Diameter: 6"

- 1 System/Ctn.

- 1 Lb./Ctn.

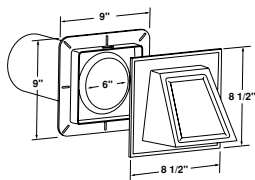

Utility Vents

Product Code/Description

EXVENT*

Louvered Exhaust Vent

Flange Dimensions:

- 9-1/2" x 9-1/2"

Surface Dimensions:

- 8.9" x 8.9"

J-Channel I.D.:

- 5/8" adjusts to 1-1/8"

Net Free Area:

- 12.5 Sq. In.
- Tube Length: 10"
- Tube Diameter: 4"
- 1 System/Ctn.
- 1.1 Lb./Ctn.

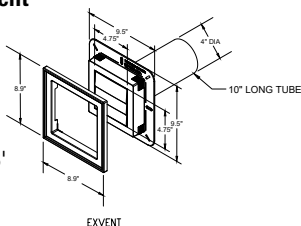

Color Availability

Available in more than 150 colors to match or coordinate with leading siding manufacturer's colors, including Paintable White (11).

EXVENT6*

6" Louvered Exhaust Vent

Flange Dimensions:

- 11-1/2" x 11-1/2"

Surface Dimensions:

- 10.9" x 10.9"

J-Channel I.D.:

- 5/8" adjusts to 1-1/8"

Net Free Area:

- 28.25 Sq. In.
- Tube Length: 10"
- Tube Diameter: 6"
- 1 System/Ctn.
- 1.3 Lb./Ctn.

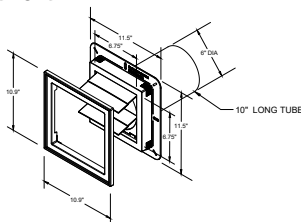

6215013DB

4" Optional EXVENT Screen Insert

- Dimensions: 4.25" x 4.25"
- Mesh dimensions: 1/8"
- 10 screens/pkg

6215014DB

6" Optional EXVENT6 Screen Insert

- Dimensions: 6.25" x 6.25"
- Mesh dimensions: 1/8"
- 10 screens/pkg

*Not approved for dryer applications with screen installed.

Utility Vents

Product Code/Description

Color Availability

INTVENT

Intake/Exhaust Vent

Flange Dimensions:

- 7-1/2" x 7-1/2"

Cap Dimensions:

- 8" x 8"

J-Channel I.D.:

- 1/2" adjusts to 1-1/4"

Net Free Area:

- 12.3 Sq. In.
- Tube Length: 10"
- Tube Diameter: 4"

- 1 Pc./Ctn.

- 1 Lb./Ctn.

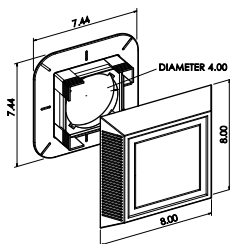

Fire Hazard

NEVER use exhaust vent with screen for dryer ventilation. Flammable lint build-up on screen can cause a fire. Always use a vent that is specifically designed for dryer applications.

Available in more than 150 colors to match or coordinate with leading siding manufacturer's colors, including Paintable White (11).

INTVENT6

6" Intake/Exhaust Vent

Flange Dimensions:

- 9-1/2" x 9-1/2"

Cap Dimensions:

- 10" x 10"

J-Channel I.D.:

- 1/2" adjusts to 1-1/4"

Net Free Area:

- 14.75 Sq. In.
- Tube Length: 10"
- Tube Diameter: 6"

- 1 Pc./Ctn.

- 1.2 Lb./Ctn.

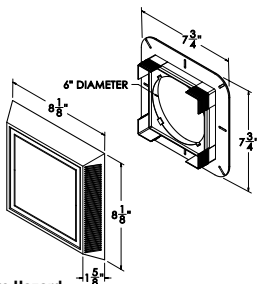

Fire Hazard

NEVER use exhaust vent with screen for dryer ventilation. Flammable lint build-up on screen can cause a fire. Always use a vent that is specifically designed for dryer applications.

FNDVENT

Foundation Vent

Flange Dimensions:

- 20" x 11-1/4"

Cap Dimensions:

- 19-7/16" x 10-11/16"

J-Channel I.D.:

- 3/4" adjust to 1-1/4"

Net Free Area:

- 48 Sq. In.
- 10 Pcs./Ctn.
- 11.94 Lbs./Ctn.

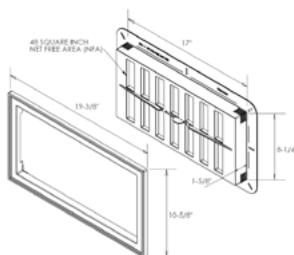

Gable Vents

Product Code/Description

RDGV18

18" Round Gable Vent

Siding Receiver:

- 3/4" – 1-1/4"
in 1/8" increments

Net Free Area:

- 48.36 Sq. In.
- 1 Pc./Ctn.
- 2.3 Lbs./Ctn.

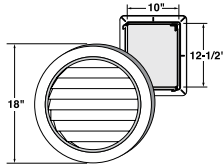

Color Availability

Available in more than 150 colors to match or coordinate with leading siding manufacturer's colors, including Paintable White (11).

RDGV

22" Round Gable Vent

Siding Receiver:

- 3/4" – 1-1/4"
in 1/8" increments

Net Free Area:

- 48.37 Sq. In.
- 1 Pc./Ctn.
- 4.1 Lbs./Ctn.

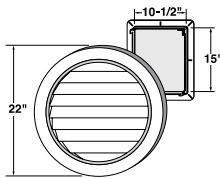

RDGV36

36" Round Gable Vent

Siding Receiver:

- 3/4" – 1-1/4"
in 1/8" increments

Net Free Area:

- 277.1 Sq. In.
- 1 Pc./Ctn.
- 8 Lbs./Ctn.

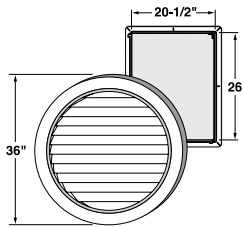

Gable Vents

Product Code/Description

Color Availability

OCTGV18

18" Octagonal Gable Vent

Siding Receiver:

- 3/4" - 1-1/4"
in 1/8" increments

Net Free Area:

- 49.72 Sq. In.
- 1 Pc./Ctn.
- 2.4 Lbs./Ctn.

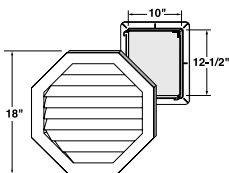

Available in more than 150 colors to match or coordinate with leading siding manufacturer's colors, including Paintable White (11).

OCTGV

22" Octagonal Gable Vent

Siding Receiver:

- 3/4" - 1-1/4"
in 1/8" increments

Net Free Area

- 49.5 Sq. In.
- 1 Pc./Ctn.
- 5 Lbs./Ctn.

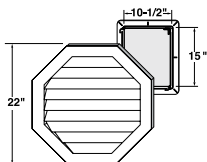

HRDGV

22" Half Round Gable Vent

Siding Receiver:

- 3/4" - 1-1/4"
in 1/8" increments

Net Free Area:

- 80.46 Sq. In.
- 1 Pc./Ctn.
- 8 Lbs./Ctn.

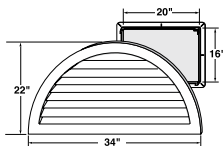

Gable Vents

Product Code/Description

RDTOPGV14

14" x 22" Round Top Gable Vent

Siding Receiver:

- 3/4" – 1-1/4"
in 1/8" increments

Net Free Area:

- 53.17 Sq. In.
- 1 Pc./Ctn.
- 2.7 Lbs./Ctn.

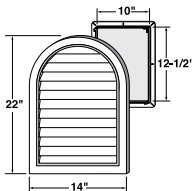

Color Availability

Available in more than 150 colors to match or coordinate with leading siding manufacturer's colors, including Paintable White (11).

RDTOPGV24

24" x 34" Round Top Gable Vent

Siding Receiver:

- 3/4" – 1-1/4"
in 1/8" increments

Net Free Area:

- 191 Sq. In.
- 1 Pc./Ctn.
- 6 Lbs./Ctn.

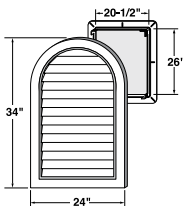

Gable Vents

Product Code/Description

SQGV1414

14" Square Gable Vent

Siding Receiver:

- 3/4" – 1-1/4"
in 1/8" increments

Net Free Area:

- 33.59 Sq. In.
- 1 Pc./Ctn.
- 2.3 Lbs./Ctn.

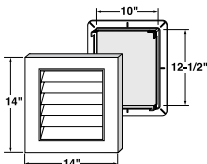

Color Availability

Available in more than 150 colors to match or coordinate with leading siding manufacturer's colors, including Paintable White (11).

RECTGV

14" x 20" Rectangular Gable Vent

Siding Receiver:

- 3/4" – 1-1/4"
in 1/8" increments

Net Free Area:

- 23.29 Sq. In.
- 1 Pc./Ctn.
- 3.83 Lbs./Ctn.

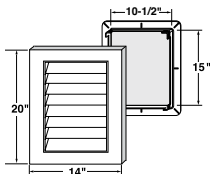

Gable Vents

Product Code/Description

RECTGV1824

18" x 24" Rectangular Gable Vent

Siding Receiver:

- 3/4" – 1-1/4"
in 1/8" increments

Net Free Area:

- 92.88 Sq. In.
- 1 Pc./Ctn.
- 5.68 Lbs./Ctn.

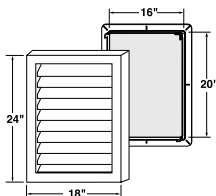

Color Availability

Available in more than 150 colors to match or coordinate with leading siding manufacturer's colors, including Paintable White (11).

RECTGV2430

24" x 30" Rectangular Gable Vent

Siding Receiver:

- 3/4" – 1-1/4"
in 1/8" increments

Net Free Area:

- 181.2 Sq. In.
- 1 Pc./Ctn.
- 9 Lbs./Ctn.

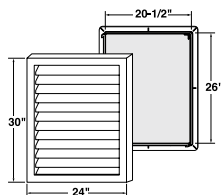

Ply Gem Accessories (Designer Accents) Color Matrix



Trim Sheet

Mastic Colors

Product Code/Description	Color Code	Color on Front	Color on Back
TS24	04	White	White
Smooth	53	Almond	White
24" Trim Sheet	350	Alpine Forest	White
• Finish: Smooth	E9	American Walnut	White
• Nominal Thickness: .019	K5	Aspen Grey	White
• Length: 50'	251	Autumn Harvest	White
• 1 Roll/Ctn.	33	Black	White
• 25 Lbs./Ctn.	147	Brandy Wood	White
Note: All colors are solid	31	Cameo	White
	36	Cape Cod Grey	White
	80	*Charcoal Grey	White
	30	Classic Cream	White
	10	Colonial Yellow	White
	135	*Copper Penny	White
	210	Corn Silk	White
	JS	Dark Bronze	White
	352	Deep Cavern	White
	090	Deep Granite	White
	22	Desert Sand	White
	390	English Wedgewood	White
	17	Everest	White
	70	Evergreen	White
	E6	Glacier Blue	White
	35	Harbor Grey	White
	IG	Hazelwood	White
	AO	Jefferson Tan	White
	IC	Lakeshore Fern	White
	44	Linen	White
	JN	London Brown	White
	148	Mahogany	White
	144	Misty Shadow	White
	IF	Montana Suede	White
	59	Musket Brown	White
	156	Natural Slate	White
	146	Newport Bay	White
	52	Pebblestone Clay	White
	IB	Portsmouth Blue	White
	170	Quiet Willow	White
	149	Red Brick	White
	E9	Red Cedar	White
	353	Rock Harbor	White
	62	Royal Brown	White
	100	Rugged Canyon	White
	290	Russet Red	White
	18	Sage	White
	39	Sandtone	White
	510	Scottish Thistle	White
	02	Silver Grey	White
	34	Terra Bronze	White
	ID	Terra Cotta	White
	275	Timberstone	White
	511	Tuscan Olive	White
	36	Victorian Grey	White
	252	Vineyard Grove	White
	354	Whispering Timber	White
	A7	Wicker	White
	E4	Woodland Green	White
	355	Woodland Retreat	White
	276	Window Almond	Window White
	09	*Window Bronze	White
	275	Window Brown	Window White
	274	Window White	Window White

TS24T

PVC Coated**24" Trim Sheet**

- (Coated one side)
- Finish: PVC Striated
- Nominal Thickness: .019
- Length: 50'
- 1 Roll/Ctn.
- 27.5 Lbs./Ctn.

Note: All colors are solid

* Colors indicated with an asterisk are not available in PVC coated.

Field forming trim sheet



Aluminum fascia covers and bird boxes



Trim Sheet

Ply Gem (Window Color Reference)

Window Manufacturer	Color Name	Matching MHE Trim
General Windows	Window White/Window White	TS24 274, S24 274
General Windows	Window Almond/Window White	TS24 276, S24 276
General Windows	Window Bronze/White	TS24 09*
General Windows	Window Brown/Window White	TS24 275, S24 275
Andersen	White/Canvas	S24 WA1*
Andersen	Terratone/Sandtone	S24 WA2*
Andersen	Cocoa Bean/Black	S24 WA5*
Andersen	Dark Bronze/Red Rock	S24 WA4*
Andersen	Forest Green/White	S24 WA6*
Marvin	Arctic White	TS24 274
Marvin	Bahama Brown	TS24 62
Marvin	Black	TS24 33
Marvin	Bronze	*TS24 09
Marvin	Cashmere	TS24 A7
Marvin	Coconut Cream	TS24 31
Marvin	*Copper	TS24 135
Marvin	Desert Beige	S24 22
Marvin	French Vanilla	*TS24 591
Marvin	Pebble Gray	SHL24 160
Marvin	Sherwood Green	TS24 70
Marvin	Sierra White	*S24 A8
Marvin	Stone White	TS24 04
Marvin	White	TS24 04
Marvin	Wineberry	TS24 755
Pella	Brown	TS24 JS
Pella	Poplar White	*TS24 PP
Pella	Putty	*TS24 PQ
Pella	Tan	*TS24 PT
Ply Gem	Adobe Clay (vinyl)	SWC24 A5
Ply Gem	Almond (BS)	SCR24 CH
Ply Gem	Beige (vinyl)	SCR24 CH
Ply Gem	Bronze (aluminum)	*TS24 09
Ply Gem	Camel/Beige	TS24 WY
Ply Gem	Clay	TS24 62
Ply Gem	Cottage Red (Mira)	*TS24 755
Ply Gem	Dark Bronze (Mira)	*TS24 09
Ply Gem	Earthtone	TS24 WU
Ply Gem	Ivory (Mira)	*TS24 APP
Ply Gem	Sandstone	TS24 WV
Ply Gem	White (all vinyl extrusions except BS1100)	TS24 04
Ply Gem	White (BS1100)	TS24 274
Ply Gem	White (Mira)	TS24 04
Simonton	Tan	TS24 276
Simonton	White	TS24 04

*Colors indicated with an asterisk are not available in PVC coated.

The listed products are "best available" match and must be customer approved using a sample.

Trim Sheet

Product Code/Description	Color Code	Color on Front	Color on Back
TS24TX PVC Texture Coated 24" Trim Sheet <ul style="list-style-type: none"> • (Coated one side) • Finish: PVC Textured • Nominal Thickness: .019 • Length: 50' • 1 Roll/Ctn. • 27.5 Lbs./Ctn. Note: The PVC texture finish has less woodgrain definition than striation.	WX	White	White
TS24150 Smooth 24" Trim Sheet <ul style="list-style-type: none"> • (Coated two sides) • Nominal Thickness: .019 • Length: 150' • 1 Roll/Ctn. • 74 Lbs./Ctn. 	04	White	White
TS24024 Smooth 24" Ultra TS® <ul style="list-style-type: none"> • (Coated two sides) • Nominal Thickness: .024 • Length: 50' • 1 Roll/Ctn. • 33.2 Lbs./Ctn. 	04 33 53 44 59 52 62 A7	White Black Almond Linen Musket Brown Pebblestone Clay Royal Brown Wicker	White White White White White White White White
TS24024T PVC Coated 24" Ultra TS® <ul style="list-style-type: none"> • (Coated one side) • Finish: PVC Striated • Nominal Thickness: .024 • Length: 50' • 1 Roll/Ctn. • 35.5 Lbs./Ctn. 	04 59	White Musket Brown	

Trim Sheet

Product Code/Description	Color Code	Color on Front	Color on Back
TS14	04	White	
Smooth	59	Musket Brown	
14" Trim Sheet			
<ul style="list-style-type: none"> • (Coated two sides) • Nominal Thickness: .019 • Length: 50' • 1 Roll/Ctn. • 15 Lbs./Ctn. 			

Trim Coil

Product Code/Description	Color Code	Color on Front	Color on Back
S24	04	White	White
Smooth	33	Black	White
24" Trim Coil	BM	*Black	Musket Brown
• (Coated two sides)	BR	*Black	Royal Brown
• Finish: Alumalure 2000®	53	Almond	White
• Nominal Thickness: .019	224	*Antique Ivory	White
• Length: 50'	251	Autumn Harvest	White
• 1 Roll/Ctn.	145	*Bayou	White
• 24.6 Lbs./Ctn.	YR	Brandy	White
	147	Brandy Wood	White
	09	*Bronze	White
	812	Brunswick	White
	31	Cameo	White
	80	*Charcoal Grey	White
	802	Cinnabar	White
	803	Civic Brownstone	White
	30	Classic Cream	White
	210	Corn Silk	White
	JS	Dark Bronze	White
	090	Deep Granite	White
	22	Desert Sand	White
	813	Dublin	White
	390	English Wedgewood	White
	17	Everest	White
	70	Evergreen	White
	262	Grecian Green	White
	35	Harbor Grey	White
	814	Iron	White
	AO	Jefferson Tan	White
	IC	Lakeshore Fern	White
	44	Linen	White
	JN	London Brown	White
	148	Mahogany	White
	144	Misty Shadow	White
	IF	Montana Suede	White
	59	Musket Brown	White
	156	Natural Slate	White
	146	Newport Bay	White
	52	Pebblestone Clay	White
	IB	Portsmouth Blue	White
	170	Quiet Willow	White
	149	Red Brick	White
	62	Royal Brown	White
	100	Rugged Canyon	White
	290	Russet Red	White
	18	Sage	White
	39	Sandtone	White
	510	Scottish Thistle	White
	02	Silver Grey	White
	34	Terra Bronze	White
	275	Timberstone	White
	511	Tuscan Olive	White
	228	Tuxedo Gray	White
	36	Victorian Grey	White
	252	Vineyard Grove	White
	A7	Wicker	White

S24T

PVC Coated**24" Trim Coil**

- (Coated one side)
- Finish: PVC Striated
- Nominal Thickness: .019
- Length: 50'
- 1 Roll/Ctn.
- 26.2 Lbs./Ctn.

* Colors indicated with an asterisk are not available in PVC coated.

Other colors may be available by Special Order. Please review the Ply Gem Performance Metals Color Offering Matrix and contact your Territory Sales Manager.

Trim Coil

Product Code/Description	Color Code	Color on Front	Color on Back
S24150 Smooth 24" Trim Coil	04 274	White Window White	
<ul style="list-style-type: none"> • Finish: Smooth • Nominal Thickness: .019 • Length: 150' • 1 Roll/Ctn. • 74.3 Lbs./Ctn. 			
S24T150 PVC Coated 24" Trim Coil			
<ul style="list-style-type: none"> • Nominal Thickness: .019 • Length: 150' • 1 Roll/Ctn. • 74.3 Lbs./Ctn. 			
S24LM Low Mar 24" Trim Coil	04 33 53 59 52 A7 62 JS Window World 274 276	White Black Almond Musket Brown Pebblestone Clay Wicker Royal Brown Dark Bronze Window White Window Almond	
<ul style="list-style-type: none"> • Finish: Textured Polymer • Nominal Thickness: .019 • Length: 50' • 1 Roll/Ctn. • 24.5 Lbs./Ctn. 			

Other colors may be available by Special Order. Please review the Ply Gem Performance Metals Color Offering Matrix and contact your Territory Sales Manager.

Trim Coil

Product Code/Description	Color Code	Color on Front	Color on Back
S24W	04	White	
Woodgrain Emboss	33	Black	
24" Trim Coil			
<ul style="list-style-type: none"> • Finish: Smooth • Nominal Thickness: .019 • Length: 50' • 1 Roll/Ctn. • 24.5 Lbs./Ctn. 			
S14	04	White	White
Smooth	BM	Black	Musket Brown
14" Trim Coil	BR	Black	Royal Brown
<ul style="list-style-type: none"> • (Coated two sides) • Finish: Smooth • Nominal Thickness: .019 • Length: 50' • 1 Roll/Ctn. • 14.4 Lbs./Ctn. 			

Trim Coil

Contractor's Choice

Product Code/Description	Color Code	Color on Front	Color on Back
C24	04	White	White
Smooth	BM	Black	Musket Brown
24" Trim Coil	BR	Black	Royal Brown
• (Coated two sides)	33	Black	White
• Finish: Smooth Polymer	59	Musket Brown	White
• Nominal Thickness: .018	52	Pebblestone Clay	White
• Length: 50'	276	Window Almond	Window White
• 1 Roll/Ctn.			
• 23.6 Lbs./Ctn.			

C24T	04	White	
PVC Coated			
24" Trim Coil			
• (Coated one side)			
• Finish: PVC Striated			
• Nominal Thickness: .018			
• Length: 50'			
• 1 Roll/Ctn.			
• 24 Lbs./Ctn.			

Envoy® Aluminum Siding

Product Code/Description

4NCR024

Envoy Rustic Double 4" (.024)

- Finish: Alupalure 2000®
- Nominal Thickness: .024
- Length: 12' 6"
- 24 Pcs./Ctn.
- 2 Sqs./Ctn.
- 90 Lbs./Ctn.

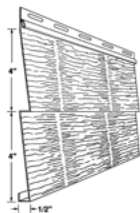

Color Availability

White
Almond
Charcoal Grey
Desert Sand
Everest
Pebblestone Clay
Rugged Canyon
Sandtone
Victorian Grey
Wicker

5N090024

Envoy Horizon Collection Double 5"

- Finish: Alupalure 2000®
- Nominal Thickness: .024
- Length: 12'
- 20 Pcs./Ctn.
- 2 Sqs./Ctn.
- 86 Lbs./Ctn.

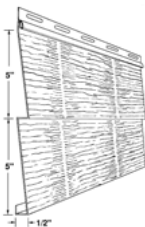

8NA

Envoy 8" Smooth

- Finish: Alupalure 2000®
- Nominal Thickness: .024
- Length: 12' 6"
- 24 Pcs./Ctn.
- 2 Sqs./Ctn.
- 84 Lbs./Ctn.



White

Endurance® Aluminum Siding

Product Code/Description

Color Availability

4NCR

**Endurance Rustic
Double 4"**

- Finish: Alupalure 2000®
- Nominal Thickness: .019
- Length: 12' 6"
- 24 Pcs./Ctn.
- 2 Sqs./Ctn.
- 71 Lbs./Ctn.

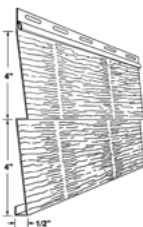

White
Almond
Charcoal Grey
Desert Sand
Everest
Pebblestone Clay
Rugged Canyon
Sandtone
Victorian Grey
Wicker

8NA019

Endurance 8" Smooth

- Finish: Alupalure 2000®
- Nominal Thickness: .019
- Length: 12' 6"
- 24 Pcs./Ctn.
- 2 Sqs./Ctn.
- 72 Lbs./Ctn.

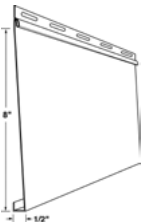

White

Aluminum Siding Accessories

Product Code/Description

Color Availability

1WAP10

Starter Strip

- Length: 10' 0"
- 40 Pcs./Ctn.
- 27 Lbs./Ctn.

* Required starter strip for Charleston Beaded and Ovation Beaded.

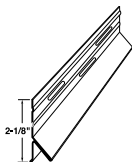

VSS10NS

Starter Strip Spring Style

- Length: 10' 0"
- 50 Pcs./Ctn.
- 33 Lbs./Ctn.

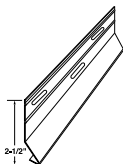

VSSSTD

Standard Aluminum Starter Strip

- Length: 10' 0"
- 2.1875" wide
- 50 Pcs./Ctn.
- 27.4 Lbs./Ctn.

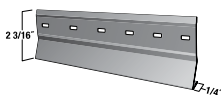

6N225NCR

Rustic Outside Aluminum Corner Post

- Finish: AlumaLure 2000®
- Nominal Thickness: .024
- Length: 10'
- 10 Pcs./Ctn.
- 31.7 Lbs./Ctn.

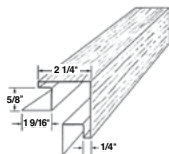

White
Almond
Charcoal Grey
Desert Sand
Everest
Pebblestone Clay
Rugged Canyon
Sandtone
Victorian Grey
Wicker

6N225

Smooth Outside Aluminum Corner Post

- Finish: AlumaLure 2000®
- Nominal Thickness: .024
- Length: 10'
- 10 Pcs./Ctn.
- 31.7 Lbs./Ctn.

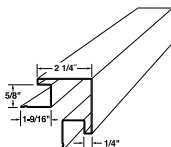

White

Aluminum Siding Accessories

 Product Code/Description

 Color Availability

2JN2A25

Window Trim "J" Style

- Finish: Alupalure 2000®
- Nominal Thickness: .019
- Length: 12' 0"
- 25 Pcs./Ctn.
- 18.8 Lbs./Ctn.

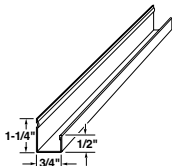
 White
 Almond
 Charcoal Grey
 Desert Sand
 Everest
 Pebblestone Clay
 Sandtone
 Victorian Grey

3F

Window Head Flashing

- Finish: Alupalure 2000®
- Nominal Thickness: .019
- Length: 12' 6"
- 20 Pcs./Ctn.
- 16.8 Lbs./Ctn.

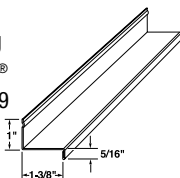
 White
 Black
 Classic Cream
 Dark Bronze
 Evergreen
 Musket Brown
 Pebblestone Clay
 Royal Brown
 Rugged Canyon

 Terra Bronze
 Wicker

Envoy® Aluminum Soffit

Product Code/Description

Color Availability

SVG12N20

Envoy
Double 6" Solid
V-Groove Soffit

- Finish: Alupalure 2000®
- Nominal Thickness: .019
- Length: 12'
- Exposure: 12"
- 20 Pcs./Ctn.
- 240 Sq. Ft./Ctn.
- 75 Lbs./Ctn.

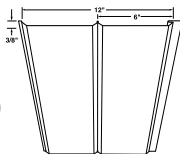

White
Black
Almond
Cameo
Charcoal Grey
Classic Cream
Dark Bronze
Desert Sand
Evergreen
Harbor Grey
Linen
Montana Suede
Musket Brown
Pebblestone Clay
Royal Brown
Rugged Canyon
Sandtone
Silver Grey
Terra Bronze
Victorian Grey
Wicker

SVG12V20

Envoy
Double 6" Perforated
V-Groove Soffit

- Finish: Alupalure 2000®
- Nominal Thickness: .019
- 15 Sq. In. N.F.A./Ft.
- Length: 12'
- Exposure: 12"
- 20 Pcs./Ctn.
- 240 Sq. Ft./Ctn.
- 67 Lbs./Ctn.

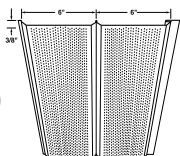

SVG6N

Envoy
6" Solid
V-Groove Soffit

- Finish: Alupalure 2000®
- Nominal Thickness: .019
- Length: 12'
- Exposure: 6"
- 20 Pcs./Ctn.
- 120 Sq. Ft./Ctn.
- 43 Lbs./Ctn.

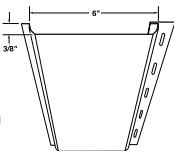

White
Almond
Charcoal Grey
Evergreen
Musket Brown
Pebblestone Clay
Sandtone
Terra Bronze

Envoy® Aluminum Soffit

 Product Code/Description

 Color Availability

SVG6V

Envoy
6" Perforated
V-Groove Soffit

- Finish: Alupalure 2000®
- Nominal Thickness: .019
- 7.5 Sq. In. N.F.A./Ft.
- Length: 12'
- Exposure: 6"
- 20 Pcs./Ctn.
- 120 Sq. Ft./Ctn.
- 39 Lbs./Ctn.

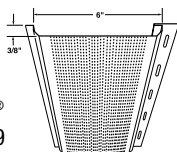

White

SAS12219

Envoy
Double 6" Solid
U-Groove Soffit

- Finish: Alupalure 2000®
- Nominal Thickness: .019
- Length: 12'
- Exposure: 12"
- 20 Pcs./Ctn.
- 240 Sq. Ft./Ctn.
- 76.1 Lbs./Ctn.

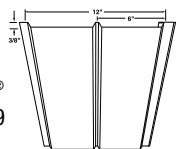
White
Musket Brown

LFAS12219

Envoy
Double 6" Lanced
U-Groove Soffit

- Finish: Alupalure 2000®
- Nominal Thickness: .019
- 10.6 Sq. In. N.F.A./Ft.
- Length: 12'
- Exposure: 12"
- 20 Pcs./Ctn.
- 240 Sq. Ft./Ctn.
- 76.1 Lbs./Ctn.

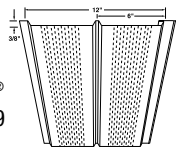

Envoy® Aluminum Soffit

Product Code/Description

Color Availability

SAS12319

Envoy

Triple 4" Solid U-Groove Soffit

- Finish: Alupalure 2000®
- Nominal Thickness: .019
- Length: 12'
- Exposure: 12"
- 20 Pcs./Ctn.
- 240 Sq. Ft./Ctn.
- 77.7 Lbs./Ctn.

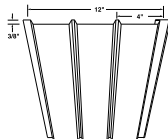

White
Black
Almond
Cameo
Charcoal Grey
Classic Cream
Dark Bronze
Desert Sand
Everest
Evergreen
Harbor Grey
Linen
Montana Suede
Musket Brown
Pebblestone Clay
Royal Brown
Rugged Canyon
Sandtone
Silver Grey
Terra Bronze
Victorian Grey
Wicker

LCAS12319

Envoy

Triple 4" Center Lanced U-Groove Soffit

- Finish: Alupalure 2000®
- Nominal Thickness: .019
- 4.4 Sq. In. N.F.A./Ft.
- Length: 12'
- Exposure: 12"
- 20 Pcs./Ctn.
- 240 Sq. Ft./Ctn.
- 77.7 Lbs./Ctn.

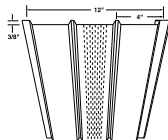

LFAS12319

Envoy

Triple 4" Full Lanced U-Groove Soffit

- Finish: Alupalure 2000®
- Nominal Thickness: .019
- 13.2 Sq. In. N.F.A./Ft.
- Length: 12'
- Exposure: 12"
- 20 Pcs./Ctn.
- 240 Sq. Ft./Ctn.
- 77.7 Lbs./Ctn.

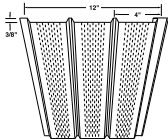

Envoy® Aluminum Soffit

Product Code/Description

SAS16419A

**Envoy
Quad 4" Solid
U-Groove Soffit**

- Finish: Alupalure 2000®
- Nominal Thickness: .019
- Length: 12'
- Exposure: 16"
- 14 Pcs./Ctn.
- 220 Sq. Ft./Ctn.
- 74.2 Lbs./Ctn.

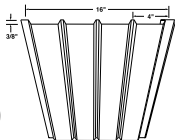

Color Availability

White
Black
Almond
Cameo
Charcoal Grey
Classic Cream
Dark Bronze
Desert Sand
Evergreen
Harbor Grey
Linen
Montana Suede
Musket Brown
Pebblestone Clay
Royal Brown
Rugged Canyon
Sandtone
Silver Grey
Terra Bronze
Victorian Grey
Wicker

LCAS16419A

**Envoy
Quad 4" Center
Lanced U-Groove Soffit**

- Finish: Alupalure 2000®
- Nominal Thickness: .019
- 9.7 Sq. In. N.F.A./Ft.
- Length: 12'
- Exposure: 16"
- 14 Pcs./Ctn.
- 220 Sq. Ft./Ctn.
- 74.2 Lbs./Ctn.

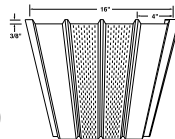

Endurance® Aluminum Soffit

Product Code/Description

Color Availability

SVG420144

**Endurance
Double 6" Solid
V-Groove Soffit**

- Finish: Alupalure 2000®
- Nominal Thickness: .016
- Length: 12'
- Exposure: 12"
- 20 Pcs./Ctn.

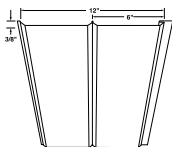

- 240 Sq Ft./Ctn.
- 65 Lbs./Ctn.

White
Black
Almond
Cameo
Charcoal Grey
Classic Cream
Dark Bronze
Desert Sand
Evergreen
Harbor Grey
Linen
Montana Suede
Musket Brown
Pebblestone Clay
Royal Brown
Sandtone
Silver Grey
Terra Bronze
Victorian Grey
Wicker

SVG420144

**Endurance
Double 6" Perforated
V-Groove Soffit**

- Finish: Alupalure 2000®
- Nominal Thickness: .016
- 15 Sq. In. N.F.A./Ft.
- Length: 12'
- Exposure: 12"
- 20 Pcs./Ctn.

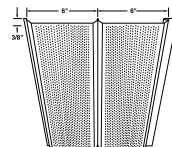

- 240 Sq Ft./Ctn.
- 59 Lbs./Ctn.

SAS12216

**Endurance
Double 6" Solid
U-Groove Soffit**

- Finish: Alupalure 2000®
- Nominal Thickness: .016
- Length: 12'
- Exposure: 12"
- 20 Pcs./Ctn.

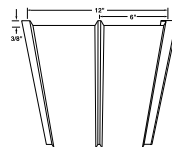

- 240 Sq Ft./Ctn.
- 67 Lbs./Ctn.

White
Musket Brown

LFAS12216

**Endurance
Double 6" Lanced
U-Groove Soffit**

- Finish: Alupalure 2000®
- Nominal Thickness: .016
- 10.6 Sq. In. N.F.A./Ft.
- Length: 12'
- Exposure: 12"
- 20 Pcs./Ctn.

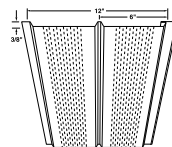

- 240 Sq Ft./Ctn.
- 67 Lbs./Ctn.

Endurance® Aluminum Soffit

Product Code/Description

Color Availability

SAS12316

**Endurance
Triple 4" Solid
U-Groove Soffit**

- Finish: Alupalure 2000®
- Nominal Thickness: .016
- Length: 12'
- Exposure: 12"
- 20 Pcs./Ctn.
- 240 Sq Ft./Ctn.
- 68 Lbs./Ctn.

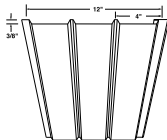

White
Black
Almond
Cameo
Charcoal Grey
Classic Cream
Dark Bronze
Desert Sand
Evergreen
Harbor Grey
Linen
Montana Suede
Musket Brown
Pebblestone Clay
Royal Brown
Rugged Canyon
Sandtone
Silver Grey
Terra Bronze
Victorian Grey
Wicker

LCAS12316

**Endurance
Triple 4" Center Lanced
U-Groove Soffit**

- Finish: Alupalure 2000®
- Nominal Thickness: .016
- 4.4 Sq. In. N.F.A./Ft.
- Length: 12'
- Exposure: 12"
- 20 Pcs./Ctn.
- 240 Sq Ft./Ctn.
- 69 Lbs./Ctn.

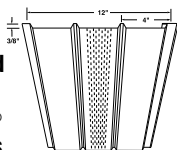

LFAS12316

**Endurance
Triple 4" Full Lanced
U-Groove Soffit**

- Finish: Alupalure 2000®
- Nominal Thickness: .016
- 13.2 Sq. In. N.F.A./Ft.
- Length: 12'
- Exposure: 12"
- 20 Pcs./Ctn.
- 240 Sq Ft./Ctn.
- 68 Lbs./Ctn.

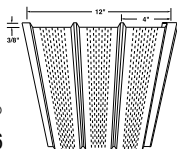

Economy Aluminum Soffit

 Product Code/Description

 Color Availability

SAS12313

White

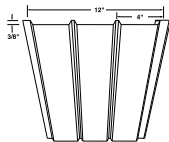
**Economy
Triple 4" Solid
U-Groove Soffit**

- Finish: Alupalure 2000®
- Nominal Thickness: .013
- Length: 12'
- Exposure: 12"
- 20 Pcs./Ctn.
- 240 Sq Ft./Ctn.
- 56 Lbs./Ctn.

LCAS12313

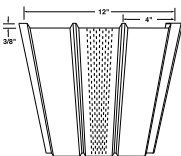
**Economy
Triple 4" Center Lanced
U-Groove Soffit**

- Finish: Alupalure 2000®
- Nominal Thickness: .013
- 4.4 Sq. In. N.F.A./Ft.
- Length: 12'
- Exposure: 12"
- 20 Pcs./Ctn.
- 240 Sq Ft./Ctn.
- 56 Lbs./Ctn.

LFAS12313

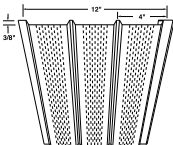
**Economy
Triple 4" Full Lanced
U-Groove Soffit**

- Finish: Alupalure 2000®
- Nominal Thickness: .013
- 13.2 Sq. In. N.F.A./Ft.
- Length: 12'
- Exposure: 12"
- 20 Pcs./Ctn.
- 240 Sq Ft./Ctn.
- 56 Lbs./Ctn.

Economy Aluminum Soffit

 Product Code/Description

 Color Availability

LFAS16413

**Economy
Quad 4" Full Lanced
U-Groove Soffit**

- Finish: Alupalure 2000®
- Nominal Thickness: .013
- 5.16 Sq. In. N.F.A./Ft.
- Length: 12'
- Exposure: 16'
- 18 Pcs./Ctn.
- 288 Sq Ft./Ctn.
- 65.25 Lbs./Ctn.

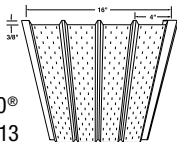
 White
 Royal Brown
 Dark Bronze

SAS16413

**Economy
Quad 4" Solid
U-Groove Soffit**

- Finish: Alupalure 2000®
- Nominal Thickness: .013
- 5.16 Sq. In. N.F.A./Ft.
- Length: 12'
- Exposure: 16'
- 18 Pcs./Ctn.
- 288 Sq Ft./Ctn.
- 65.25 Lbs./Ctn.

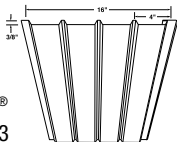
 White
 Royal Brown
 Dark Bronze

Aluminum Fascia

Product Code/Description

Color Availability

F1C425

Envoy Smooth 4" Fascia Trim

- Finish: Alupalure 2000®
- Nominal Thickness: .024
- Length: 12'
- 25 Pcs./Ctn.
- 41 Lbs./Ctn.

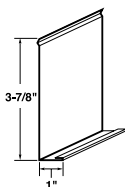

White
Black
Almond
Cameo
Dark Bronze
Desert Sand
Evergreen
Linen
Montana Suede
Musket Brown
Pebblestone Clay
Royal Brown
Sandtone

Terra Bronze
Wicker

F1C625

Envoy Smooth 6" Fascia Trim

- Finish: Alupalure 2000®
- Nominal Thickness: .024
- Length: 12'
- 25 Pcs./Ctn.
- 55 Lbs./Ctn.

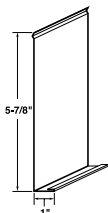

White
Black
Almond
Cameo
Charcoal Grey
Classic Cream
Dark Bronze
Desert Sand
Everest
Evergreen
Harbor Grey
Linen
Montana Suede
Musket Brown
Pebblestone Clay
Royal Brown
Rugged Canyon
Sandtone
Silver Grey
Terra Bronze
Victorian Grey
Wicker

F1C825

Envoy Smooth 8" Fascia Trim

- Finish: Alupalure 2000®
- Nominal Thickness: .024
- Length: 12'
- 25 Pcs./Ctn.
- 71 Lbs./Ctn.

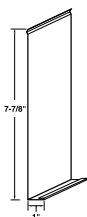

White
Almond
Cameo
Dark Bronze
Desert Sand
Linen
Musket Brown
Pebblestone Clay
Terra Bronze
Wicker

F1C1025

Envoy Smooth 10" Fascia Trim

- Finish: Alupalure 2000®
- Nominal Thickness: .024
- Length: 12'
- 25 Pcs./Ctn.
- 85 Lbs./Ctn.



Optional
aluminum
fascia covers

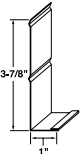
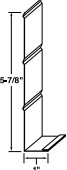
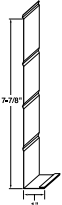
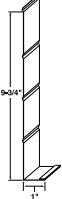

Aluminum Fascia

Product Code/Description	Color Availability
<p>F1C4SR02425 Envoy Ribbed 4" Fascia Trim</p> <ul style="list-style-type: none"> • Finish: Alupalure 2000® • Nominal Thickness: .024 • Length: 12' • 25 Pcs./Ctn. • 41 Lbs./Ctn. 	<p>White Black Almond Cameo Dark Bronze Desert Sand Evergreen Linen Montana Suede Musket Brown</p> <p>Pebblestone Clay Royal Brown Sandtone Terra Bronze Wicker</p>
<p>F1C6SR02425 Envoy Ribbed 6" Fascia Trim</p> <ul style="list-style-type: none"> • Finish: Alupalure 2000® • Nominal Thickness: .024 • Length: 12' • 25 Pcs./Ctn. • 55 Lbs./Ctn. 	<p>White Black Almond Cameo Charcoal Grey Classic Cream Dark Bronze Desert Sand Evergreen Harbor Grey Linen Montana Suede Musket Brown Pebblestone Clay Royal Brown Rugged Canyon Sandtone Silver Grey Terra Bronze Victorian Grey Wicker</p>
<p>F1C8SR02425 Envoy Ribbed 8" Fascia Trim</p> <ul style="list-style-type: none"> • Finish: Alupalure 2000® • Nominal Thickness: .024 • Length: 12' • 25 Pcs./Ctn. • 71 Lbs./Ctn. 	<p>White Almond Cameo Dark Bronze Desert Sand Linen Musket Brown Pebblestone Clay Terra Bronze Wicker</p>
<p>F1C10SR02425 Envoy Ribbed 10" Fascia Trim</p> <ul style="list-style-type: none"> • Finish: Alupalure 2000® • Nominal Thickness: .024 • Length: 12' • 25 Pcs./Ctn. • 85 Lbs./Ctn. 	<p>White Almond Cameo Dark Bronze Desert Sand Linen Musket Brown Pebblestone Clay Terra Bronze Wicker</p>

Aluminum Fascia

Product Code/Description

Color Availability

F1C4SR25

**Endurance Ribbed
4" Fascia Trim**

- Finish: AlumaLure 2000®
- Nominal Thickness: .019
- Length: 12'
- 25 Pcs./Ctn.
- 35 Lbs./Ctn.

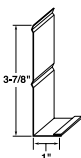

- White
- Almond
- Cameo
- Dark Bronze
- Desert Sand
- Linen
- Musket Brown
- Pebblestone Clay
- Royal Brown
- Terra Bronze
- Wicker

F1C6SR25

**Endurance Ribbed
6" Fascia Trim**

- Finish: AlumaLure 2000®
- Nominal Thickness: .019
- Length: 12'
- 25 Pcs./Ctn.
- 47 Lbs./Ctn.

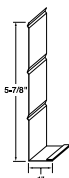

- White
- Black
- Almond
- Cameo
- Charcoal Grey
- Classic Cream
- Dark Bronze
- Desert Sand
- Evergreen
- Linen
- Montana Suede
- Musket Brown
- Pebblestone Clay
- Royal Brown
- Rugged Canyon
- Sandtone
- Terra Bronze
- Wicker

F1C8SR25

**Endurance Ribbed
8" Fascia Trim**

- Finish: AlumaLure 2000®
- Nominal Thickness: .019
- Length: 12'
- 25 Pcs./Ctn.
- 59 Lbs./Ctn.

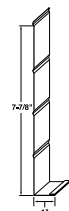

- White
- Almond
- Cameo
- Dark Bronze
- Desert Sand
- Musket Brown
- Pebblestone Clay
- Terra Bronze
- Wicker

F1C10SR25

**Endurance Ribbed
10" Fascia Trim**

- Finish: AlumaLure 2000®
- Nominal Thickness: .019
- Length: 12'
- 25 Pcs./Ctn.
- 72 Lbs./Ctn.

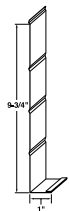

- White
- Almond
- Classic Cream
- Wicker

GRT6SR12

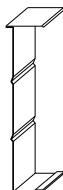

**Gable Rake
6" Fascia Trim**

- Finish: AlumaLure 2000®
- Nominal Thickness: .019
- Length: 12'
- 12 Pcs./Ctn.
- 27 Lbs./Ctn.

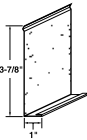

PLY GEM PERFORMANCE METALS

Aluminum Fascia

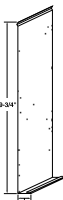
Product Code/Description	Color Availability
<p>F1C4025 Envoy Wood Grain Embossed 4" Fascia Trim</p> <ul style="list-style-type: none"> • Finish: Alumalure 2000® • Nominal Thickness: .024 • Length: 12' • 25 Pcs./Ctn. • 41 Lbs./Ctn. 	<p>White Black Almond Cameo Dark Bronze Desert Sand Evergreen Linen Montana Suede Musket Brown Pebblestone Clay</p> <p>Royal Brown Sandtone Terra Bronze Wicker</p>
<p>F1C6025 Envoy Wood Grain Embossed 6" Fascia Trim</p> <ul style="list-style-type: none"> • Finish: Alumalure 2000+ • Nominal Thickness: .024 • Length: 12' • 25 Pcs./Ctn. • 55 Lbs./Ctn. 	<p>White Black Almond Cameo Charcoal Grey Classic Cream Dark Bronze Desert Sand Evergreen Harbor Grey Linen Montana Suede Musket Brown Pebblestone Clay Royal Brown Rugged Canyon Sandtone Silver Grey Terra Bronze Victorian Grey Wicker</p>
<p>F1C8025 Envoy Wood Grain Embossed 8" Fascia Trim</p> <ul style="list-style-type: none"> • Finish: Alumalure 2000® • Nominal Thickness: .024 • Length: 12' • 25 Pcs./Ctn. • 71 Lbs./Ctn. 	<p>White Almond Cameo Dark Bronze Desert Sand Linen Musket Brown Pebblestone Clay Terra Bronze Wicker</p>
<p>F1C10025 Envoy Wood Grain Embossed 10" Fascia Trim</p> <ul style="list-style-type: none"> • Finish: Alumalure 2000® • Nominal Thickness: .024 • Length: 12' • 25 Pcs./Ctn. • 85 Lbs./Ctn. 	<p>White Almond Cameo Dark Bronze Desert Sand Linen Musket Brown Pebblestone Clay Terra Bronze Wicker</p>

Aluminum Soffit and Fascia Accessories

Product Code/Description

Color Availability

4APN20

General Purpose Trim

- Finish: Alupalure 2000®
- Nominal Thickness: .019
- Length: 12' 6"
- 20 Pcs./Ctn.
- 14.3 Lbs./Ctn.

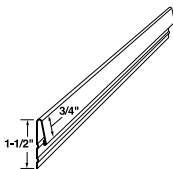

White
Black
Almond
Cameo
Charcoal Grey
Classic Cream
Dark Bronze
Desert Sand
Evergreen
Linen
Montana Suede

Musket Brown
Pebblestone Clay
Royal Brown
Rugged Canyon
Sandtone
Terra Bronze
Victorian Grey
Wicker

F438

J-Channel - 3/8" 1" Face, Offset

- Finish: Alupalure 2000®
- Nominal Thickness: .019
- Length: 12' 1"
- 40 Pcs./Ctn.
- 42 Lbs./Ctn.

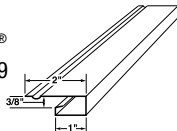

White
Black
Almond
Cameo
Charcoal Grey
Classic Cream
Dark Bronze
Desert Sand
Evergreen
Harbor Grey
Linen
Montana Suede

Musket Brown
Pebblestone Clay
Royal Brown
Rugged Canyon
Sandtone
Silver Grey
Terra Bronze
Victorian Grey
Wicker

Use: 3/8" Soffit

F438425

J-Channel - 3/8" 3/4" Face

- Finish: Alupalure 2000®
- Nominal Thickness: .016
- Length: 12' 0"
- 25 Pcs./Ctn.
- 19 Lbs./Ctn.

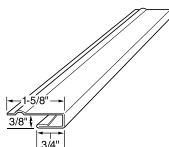

White
Black
Almond
Cameo
Charcoal Grey
Classic Cream
Dark Bronze
Desert Sand
Everest
Evergreen
Harbor Grey
Linen
Montana Suede
Musket Brown
Pebblestone Clay

Royal Brown
Rugged Canyon
Sandtone
Silver Grey
Terra Bronze
Victorian Grey
Wicker

Use: 3/8" Soffit

Aluminum Soffit and Fascia Accessories

Product Code/Description

Color Availability

SJ1625

J-Channel - 1/2"
3/4" Face

- Finish: Alumalure 2000®
- Nominal Thickness: .016
- Length: 12' 0"
- 25 Pcs./Ctn.
- 18 Lbs./Ctn.

Use: 1/2" Soffit

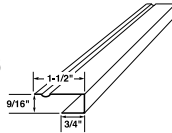

- White
- Black
- Almond
- Cameo
- Classic Cream
- Dark Bronze
- Desert Sand
- Evergreen
- Linen
- Musket Brown
- Pebblestone Clay

- Royal Brown
- Rugged Canyon
- Sandtone
- Silver Grey
- Terra Bronze
- Wicker

58ALJ25

J-Channel - 5/8"
1" Face

- Finish: Alumalure 2000®
- Nominal Thickness: .019
- Length: 12'
- 25 Pcs./Ctn.
- 22.5 Lbs./Ctn.

Note: For use with 5/8" vinyl soffit

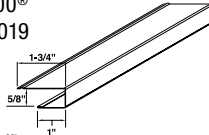

- White
- Almond
- Cameo
- Charcoal Grey
- Classic Cream
- Desert Sand
- Everest
- Harbor Grey
- Linen
- Montana Suede
- Musket Brown

- Pebblestone Clay
- Rugged Canyon
- Sandtone
- Silver Grey
- Victorian Grey
- Wicker

78ALJ25

J-Channel - 7/8"

- Finish: Alumalure 2000®
- Nominal Thickness: .019
- Length: 12'
- 25 Pcs./Ctn.
- 26 Lbs./Ctn.

Note: For use with 5/8" or 3/4" vinyl siding and soffit.

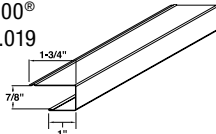

- White
- Almond
- Cameo
- Classic Cream
- Desert Sand
- Linen
- Montana Suede
- Pebblestone Clay
- Sandtone
- Wicker

SAT38

T-Channel - 3/8"
1 1/4" Face

- Finish: Alumalure 2000®
- Nominal Thickness: .019
- Length: 10'
- 10 Pcs./Ctn.
- 14 Lbs./Ctn.

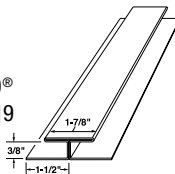

- White
- Black
- Almond
- Cameo
- Classic Cream
- Dark Bronze
- Desert Sand
- Evergreen
- Linen
- Montana Suede

- Musket Brown
- Pebblestone Clay
- Royal Brown
- Rugged Canyon
- Sandtone
- Silver Grey
- Terra Bronze
- Wicker

Aluminum Soffit and Fascia Accessories

Product Code/Description

Color Availability

F8S25

F-Channel - 3/8"

1-1/4" Face

- Finish: Alumalure 2000®
- Nominal Thickness: .019
- Length: 12'
- 25 Pcs./Ctn.
- 37 Lbs./Ctn.

Use: 3/8" Soffit

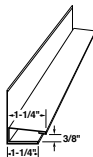

White
Black
Almond
Cameo
Charcoal Grey
Classic Cream
Dark Bronzeze
Desert Sand
Everest
Evergreen
Harbor Grey
Linen
Montana Suede
Musket Brown
Pebblestone Clay

Royal Brown
Rugged Canyon
Sandtone
Silver Grey
Terra Bronze
Victorian Grey
Wicker

F12

F-Channel - 1/2"

5/8" Face

- Finish: Alumalure 2000®
- Nominal Thickness: .019
- Length: 12' 0"
- 25 Pcs./Ctn.
- 20 Lbs./Ctn.

Use: 1/2" Soffit

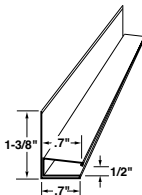

White
Musket Brown

SF1625

F-Channel - 1/2"

1" Face

- Finish: Alumalure 2000®
- Nominal Thickness: .019
- Length: 12'
- 25 Pcs./Ctn.
- 37 Lbs./Ctn.

Use: 1/2" Soffit

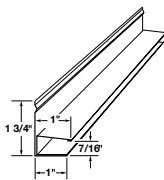

White
Almond
Cameo
Desert Sand
Linen
Musket Brown
Pebblestone Clay
Royal Brown
Sandtone
Silver Grey
Terra Bronze
Wicker

SF58

F-Channel - 5/8"

1" Face

- Finish: Alumalure 2000®
- Nominal Thickness: .019
- Length: 12' 1"
- 24 Pcs./Ctn.
- 38 Lbs./Ctn.

For use with 5/8" Vinyl Soffit

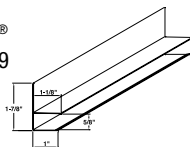

White
Almond
Cameo
Pebblestone Clay
Wicker

Aluminum Soffit and Fascia Accessories

Product Code/Description

WBTU

Touch-Up Paint

- (Bottled with brush)
- 1 Oz./Plastic Bottles
- 6/Ctn.
- 0.9 Lb./Ctn.



TN1250

#15 Stainless Steel Trim Nails - 1-1/4"

- 1 Lb./Ctn.

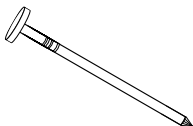

Color Availability

Black	Rugged Canyon
Almond	Sandtone
Cameo	Silver Grey
Charcoal Grey	Terra Bronze
Classic Cream	Victorian Grey
Dark Bronze	Wicker
Desert Sand	White
Everest	
Evergreen	
Harbor Grey	
Linen	
Montana Suede	
Musket Brown	
Pebblestone Clay	
Royal Brown	

Roof and Eave Ventilation Products

 Product Code/Description

 Color Availability

VAR

Vent-A-Ridge®

- Aluminum
- Length: 10'
- 12 Pcs./Ctn.
- 18 Sq. In. Net Free Ventilation/Ln. Ft.
- 52 Lbs./Ctn.

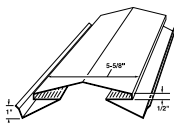
 White
 Black
 Musket Brown

VAREP36

End Plug for VAR

- Solid Polymer
- 36 Pcs./Ctn.
- 5 Lbs./Ctn.

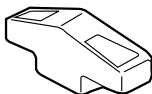
Black

VAS70

Vent-A-Strip (Model 70)

- Aluminum
- Length: 8'
- 36 Pcs./Ctn.
- 8.8 Sq. In. Net Free Ventilation/Ln. Ft.
- 29 Lbs./Ctn.

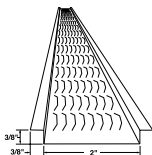

Mill

 White
 Musket Brown

VAS79

Vent-A-Strip (Model 79)

- Aluminum
- Length: 8'
- 36 Pcs./Ctn.
- 9.9 Sq. In. Net Free Ventilation/Ln. Ft.
- 33 Lbs./Ctn.

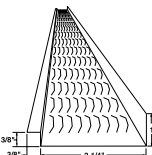

Gutter Coil

Description	Product Code	Thickness (nominal)	Width	Nominal Length	Target Coil Weight (+/-50 Lbs.)	Fl./Lb. Conversion	Color Availability
Gutter Coil One-Side Finish Coat • 16" Center I.D.	GC11750	.027	11.750"	950	350	2.713	30° White (Medium Gloss)
	GC1175032	.032	11.750"	825	350	2.36	80° White (High Gloss)
	GC11875	.027	11.875"	940	350	2.684	Black
	GC1187532	.032	11.875"	820	350	2.306	Almond
	GC1300032	.032	13.000"	750	350	2.133	Cameo
	GC15000	.027	15.000"	750	350	2.125	Charcoal Grey
	GC1500032	.032	15.000"	650	350	1.849	Classic Cream
							Dark Bronze
						Desert Sand	
						Evergreen	
						Jefferson Tan	
						Linen	
						Montana Suede	
						Musket Brown	
						Pebblestone Clay	
						Royal Brown	
						Rugged Canyon	
						Sandtone	
						Silver Grey	
						Terra Bronze	
						Victorian Grey	
						Wicker	



Extended Lead Time Colors

Everest
Harbor Grey



*These colors are only available in .032" and does not include 13"

Downspout Coil

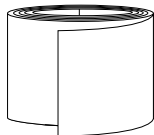
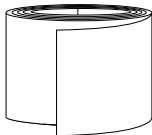
Description	Product Code	Thickness (nominal)	Width	Weight Target (Lbs.)	Color Availability
2 x 3 Downspout Coil <ul style="list-style-type: none"> • 16" Center I.D. • 3615' per Roll/appx. • 750# = 3615' appx. 	DC10500	.019	10.500"	(±75)	30° White (Medium Gloss) 80° White (High Gloss) Black Almond Cameo Charcoal Grey Classic Cream Dark Bronze Desert Sand Evergreen Jefferson Tan Linen Montana Suede Musket Brown Pebblestone Clay Royal Brown Sandtone Terra Bronze Victorian Grey Wicker
				750	
3 x 4 Downspout Coil <ul style="list-style-type: none"> • 16" Center I.D. • 1000 lb. = 3680' appx. • 500 lb. = 1840' appx. 	DC13750	.019	13.750"	(±75)	30° White (Medium Gloss) 80° White (High Gloss) Black Almond Cameo Charcoal Grey Classic Cream Dark Bronze Desert Sand Evergreen Jefferson Tan Linen Montana Suede Musket Brown Pebblestone Clay Royal Brown Sandtone Terra Bronze Victorian Grey Wicker
	DC1375500	.019	13.750"	500	

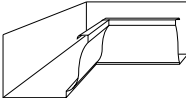
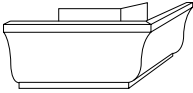

Gutter Accessories

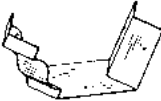
Product Code/Description	Color Availability
<p>IBM5 5" Inside Box Miter</p> <ul style="list-style-type: none"> • Nominal Thickness: .019 • 20 Pcs./Ctn. • 8 Lbs./Ctn. 	<p>30° White (Medium Gloss) 80° White (High Gloss) Black Almond Cameo Charcoal Grey Classic Cream Dark Bronze Desert Sand Everest Evergreen Harbor Grey Jefferson Tan Linen Montana Suede Musket Brown Pebblestone Clay Royal Brown Rugged Canyon Sandtone Silver Grey Terra Bronze Victorian Grey Wicker</p>
<p>OBM5 5" Outside Box Miter</p> <ul style="list-style-type: none"> • Nominal Thickness: .019 • 20 Pcs./Ctn. • 8 Lbs./Ctn. 	
<p>ISM5 5" Inside Strip Miter</p> <ul style="list-style-type: none"> • Nominal Thickness: .032 • 20 Pcs./Ctn. • 2.2 Lbs./Ctn. 	
<p>OSM5 5" Outside Strip Miter</p> <ul style="list-style-type: none"> • Nominal Thickness: .032 • 20 Pcs./Ctn. • 2.3 Lbs./Ctn. 	

*Not available in OBM5

*Not available in OSM5

*Not available in IBM5 or ISM5

Gutter Accessories

Product Code/Description

ISBAY5

5" Inside 45° Bay Miter

- Nominal Thickness: .032
- 12 Pcs./Ctn.
- 1.1 Lbs./Ctn.



OSBAY5

5" Outside 45° Bay Miter

- Nominal Thickness: .032
- 12 Pcs./Ctn.
- 1.1 Lbs./Ctn.

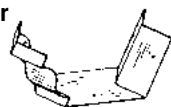

Color Availability

30° White
(Medium Gloss/Paintable)
80° White
(High Gloss)
Black
Almond
Cameo
Dark Bronze
Musket Brown
Pebblestone Clay
Royal Brown
Wicker

EC5L

5" Left End Caps

- Nominal Thickness: .019
- 50 Pcs./Ctn.
- 2.6 Lbs./Ctn.

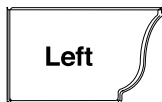

30° White
(Medium Gloss)
80° White
(High Gloss)

Black
Almond
Cameo
Charcoal Grey
Classic Cream
Dark Bronze
Desert Sand
Everest
Evergreen
Harbor Grey
Jefferson Tan
Linen
Montana Suede
Musket Brown
Pebblestone Clay
Royal Brown
Rugged Canyon
Sandtone
Silver Grey
Terra Bronze
Victorian Grey
Wicker



EC5R

5" Right End Caps

- Nominal Thickness: .019
- 50 Pcs./Ctn.
- 2.6 Lbs./Ctn.

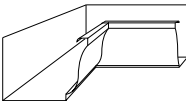
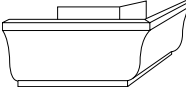

Gutter Accessories

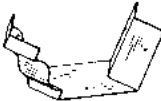
Product Code/Description	Color Availability
<p>IBM6 6" Inside Box Miter</p> <ul style="list-style-type: none"> Nominal Thickness: .019 20 Pcs./Ctn. 13 Lbs./Ctn. 	<p>30° White (Medium Gloss) 80° White (High Gloss) Black Almond Cameo Charcoal Grey Classic Cream Dark Bronze Desert Sand Everest Evergreen Harbor Grey Jefferson Tan Linen Montana Suede Musket Brown Pebblestone Clay Royal Brown Rugged Canyon Sandtone Silver Grey Terra Bronze Victorian Grey Wicker</p>
<p>OBM6 6" Outside Box Miter</p> <ul style="list-style-type: none"> Nominal Thickness: .019 20 Pcs./Ctn. 12 Lbs./Ctn. 	
<p>ISM6 6" Inside Strip Miter</p> <ul style="list-style-type: none"> Nominal Thickness: .032 20 Pcs./Ctn. 3.4 Lbs./Ctn. 	
<p>OSM6 6" Outside Strip Miter</p> <ul style="list-style-type: none"> Nominal Thickness: .032 20 Pcs./Ctn. 3.2 Lbs./Ctn. 	

*Not available in OBM6

**Not available in OSM6

Gutter Accessories

Product Code/Description

Color Availability

ISBAY6

6" Inside 45° Bay Miter

- Nominal Thickness: .032
- 12 Pcs./Ctn.
- 2 Lbs./Ctn.



30° White
(Medium Gloss/Paintable)
80° White
(High Gloss)
Black
Almond
Cameo
Dark Bronze
Musket Brown
Pebblestone Clay
Royal Brown
Wicker

OSBAY6

6" Outside 45° Bay Miter

- Nominal Thickness: .032
- 12 Pcs./Ctn.
- 2 Lbs./Ctn.



EC6L

6" Left End Caps

- Nominal Thickness: .019
- 50 Pcs./Ctn.
- 3.6 Lbs./Ctn.

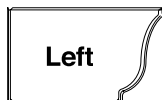

30° White
(Medium Gloss)
80° White
(High Gloss)
Black
Almond
Cameo
Classic Cream
Charcoal Grey
Dark Bronze
Desert Sand
Everest
Evergreen
Harbor Grey
Jefferson Tan

Linen
Montana Suede
Musket Brown
Pebblestone Clay
Royal Brown
Rugged Canyon
Sandtone
Silver Grey
Terra Bronze
Victorian Grey
Wicker

EC6R

6" Right End Caps

- Nominal Thickness: .019
- 50 Pcs./Ctn.
- 3.6 Lbs./Ctn.



Gutter Accessories

Product Code/Description

Color Availability

ROT2X3

Outlet Tubes

- 2" x 3" Rectangular
- 30 Pcs./Ctn.
- 1.9 Lbs./Ctn.

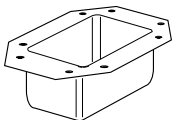

Mill Finish

ROT3X4

Outlet Tubes

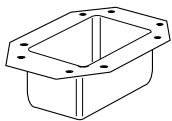

- 3" x 4" Rectangular
- 50 Pcs./Ctn.
- 3.9 Lbs./Ctn.



Gutter and Downspout Coil Accessories

Product Code/Description	Color Availability
<p>AM5HID Aluminum 5" Hidden Hanger</p> <ul style="list-style-type: none"> • Nominal Thickness: .065 • 100 Pcs./Ctn. • 6 Lbs./Ctn. 	<p>Mill Finish</p>
<p>AM5ZIP500 Aluminum 5" Zip Hanger</p> <ul style="list-style-type: none"> • 500 Pcs./Ctn. • 37 Lbs./Ctn. 	<p>Mill Finish</p>
<p>AM6ZIP Aluminum 6" Zip Hanger</p> <ul style="list-style-type: none"> • 50 Pcs./Ctn. • 5 Lbs./Ctn. 	<p>Mill Finish</p>
<p>GS50Z Gutter Seal</p> <ul style="list-style-type: none"> • 24 Tubes./Ctn. • 8 Lbs./Ctn. • 5 oz. 	<p>Mill Finish</p>
<p>GSW40Z J1 Gutter Seal</p> <ul style="list-style-type: none"> • 12 Tubes./Ctn. • 3.75 Lbs./Ctn. • 4 oz. 	<p>White</p>
<p>ASDIV Valley Water Diverter</p> <ul style="list-style-type: none"> • 30 Pcs./Ctn. • 1.6 Lbs./Ctn. 	<p>White</p>

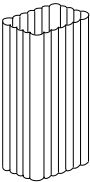
Downspouts and Accessories

Product Code/Description	Color Availability
<p>DS2X3 2" x 3" Downspout Length: 10'</p> <ul style="list-style-type: none"> • Nominal Thickness: .019 • 10 Pcs./Ctn. • 26 Lbs./Ctn. <p>Note: Minimum order-one carton.</p>	 <p>30° White (Medium Gloss) 80° White (High Gloss) Black Almond Cameo Charcoal Grey Classic Cream Dark Bronze Desert Sand Evergreen Harbor Grey Jefferson Tan Linen Montana Suede Musket Brown Pebblestone Clay Royal Brown Rugged Canyon Sandtone Silver Grey Terra Bronze Victorian Grey Wicker</p>
<p>E2X3A 2" x 3" Elbow, Style A</p> <ul style="list-style-type: none"> • Nominal Thickness: .019 • 30 Pcs./Ctn. • 7 Lbs./Ctn. <p>Note: Minimum order-one carton.</p>	 <p>75°</p>
<p>E2X3B 2" x 3" Elbow, Style B</p> <ul style="list-style-type: none"> • Nominal Thickness: .019 • 30 Pcs./Ctn. • 7 Lbs./Ctn. <p>Note: Minimum order-one carton.</p>	 <p>75°</p> <p>Extended Lead Time Colors Everest</p>



*Not available in DS2x3A & DS2x3B

**Not available in DS2x3

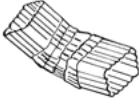
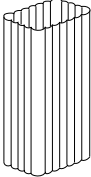
Downspouts and Accessories

Product Code/Description	Color Availability
<p>E2X3A30 2" x 3" Elbow, 30° Style A</p> <ul style="list-style-type: none"> Nominal Thickness: .019 30 Pcs./Ctn. 7 Lbs./Ctn. <p>Use: short overhang / ledges</p> 	<p>30° White (Medium Gloss) Linen 80° White (High Gloss) Musket Brown Black Pebblestone Clay Almond Royal Brown Cameo Sandtone Classic Cream Terra Bronze Dark Bronze Victorian Grey Desert Sand Wicker Evergreen</p>
<p>DS2X38 2" x 3" Downspout</p> <ul style="list-style-type: none"> Nominal Thickness: .019 Length: 8' 10 Pcs./Ctn. 20 Lbs./Ctn. <p>Note: Minimum order-one carton.</p> 	<p>30° White (Medium Gloss)</p>

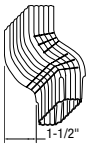
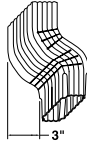
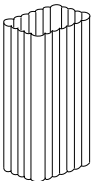
Downspouts and Accessories

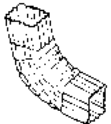

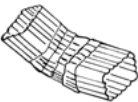
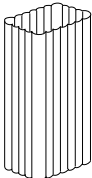
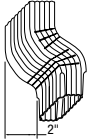
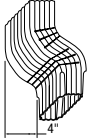
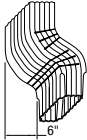

Product Code/Description	Color Availability
<p>LEDGE152X3 2" x 3" Downspout with 1.5" Offset</p> <ul style="list-style-type: none"> • Nominal Thickness: .019 • 25 Pcs./Ctn. • 6 Lbs./Ctn. 	 <p>30° White (Medium Gloss) 80° White (High Gloss) Musket Brown Pebblestone Clay</p>
<p>LEDGE302X3 2" x 3" Downspout with 3" Offset</p> <ul style="list-style-type: none"> • Nominal Thickness: .019 • 20 Pcs./Ctn. • 6 Lbs./Ctn. 	
<p>DS3X4 3" x 4" Downspout</p> <ul style="list-style-type: none"> • Nominal Thickness: .019 • Length: 10' • 10 Pcs./Ctn. • 34 Lbs./Ctn. <p>Note: Minimum order-one carton.</p>	 <p>30° White (Medium Gloss) 80° White (High Gloss) Black Almond Cameo Charcoal Grey Classic Cream Dark Bronze Desert Sand Evergreen Harbor Grey Jefferson Tan Linen Montana Suede Musket Brown Pebblestone Clay Royal Brown Rugged Canyon Sandtone Silver Grey Terra Bronze Victorian Grey Wicker</p>
<p>E3X4A 3" x 4" Elbow, Style A</p> <ul style="list-style-type: none"> • Nominal Thickness: .019 • 20 Pcs./Ctn. • 7 Lbs./Ctn. <p>Note: Minimum order-one carton.</p>	 <p>75°</p>
<p>E3X4B 3" x 4" Elbow, Style B</p> <ul style="list-style-type: none"> • Nominal Thickness: .019 • 20 Pcs./Ctn. • 8 Lbs./Ctn. <p>Note: Minimum order-one carton.</p>	 <p>75°</p> <p>Extended Lead Time Colors Everest</p>

PLY GEM PERFORMANCE METALS

Downspouts and Accessories

Product Code/Description	Color Availability
<p>E3X4A30 3" x 4" Elbow, 30° Style A</p> <ul style="list-style-type: none"> Nominal Thickness: .019 20 Pcs./Ctn. 8 Lbs./Ctn. <p>Use: short overhang / ledges</p>	 <ul style="list-style-type: none"> 30° White (Medium Gloss) 80° White (High Gloss) Black Almond Cameo Classic Cream Dark Bronze Desert Sand Evergreen Linen Musket Brown Pebblestone Clay Royal Brown Sandtone Terra Bronze Victorian Grey Wicker
<p>DS3X48 3" x 4" Downspout</p> <ul style="list-style-type: none"> Nominal Thickness: .019 Length: 8' 10 Pcs./Ctn. 29 Lbs./Ctn. <p>Note: Minimum order-one carton.</p>	 <ul style="list-style-type: none"> 30° White (Medium Gloss)
<p>LEDGE203X4 3" x 4" Downspout with 2" Offset</p> <ul style="list-style-type: none"> Nominal Thickness: .019 12 Pcs./Ctn. 5.5 Lbs./Ctn. 	 <ul style="list-style-type: none"> 30° White (Medium Gloss) 80° White (High Gloss) Musket Pebblestone Clay
<p>LEDGE403X4 3" x 4" Downspout with 4" Offset</p> <ul style="list-style-type: none"> Nominal Thickness: .019 12 Pcs./Ctn. 5.7 Lbs./Ctn. 	
<p>LEDGE603X4 3" x 4" Downspout with 6" Offset</p> <ul style="list-style-type: none"> Nominal Thickness: .019 12 Pcs./Ctn. 6.5 Lbs./Ctn. 	

Gutter and Downspout Coil Accessories

Product Code/Description	Color Availability
<p>DPB Downspout Pipe Band -Universal</p> <ul style="list-style-type: none"> • (Fits 2" x 3" or 3" x 4" Downspout) • 100 Pcs./Ctn. • Packaged Flat • 3.6 Lbs./Ctn. 	<p>30° White (Medium Gloss) 80° White (High Gloss) Black Almond Cameo Charcoal Grey Classic Cream Dark Bronze Desert Sand Everest Evergreen Harbor Grey Jefferson Tan† Linen Montana Suede Musket Brown</p> <p>Pebblestone Clay Royal Brown Rugged Canyon Sandtone Silver Grey Terra Bronze Victorian Grey Wicker</p>
<p>GR1 1/8" Bind Pop Rivets*</p> <ul style="list-style-type: none"> • 100 Pcs./Bag • 10 Bags/Box • 1.25 Lbs./Box <p>* Not available in J0 or J1.</p> 	<p>*Not available in DPB †Not available in GCTU & GCTU1</p>
<p>GZS8 #8 x 1/2" Zip Screws</p> <ul style="list-style-type: none"> • 100 Pcs./Bag • 10 Bags/Ctn. • 3.8 Lbs./Ctn. 	
<p>GCTU Touch Up Paint (Aerosol)</p> <ul style="list-style-type: none"> • 12 Ozs./Can • 12 Cans/Ctn. • 12.6 Lbs./Ctn. <p>* Extended Lead Time.</p> 	
<p>GCTU1 Touch Up Paint (Aerosol Single Can)</p> <ul style="list-style-type: none"> • 12 Ozs./Can • 1 Can/Ctn. • 1.2 Lb./Ctn. <p>* Extended Lead Time.</p> 	

PLY GEM PERFORMANCE METALS

Metal Accessories Program

for Fiber Cement

James Hardie Colors

Category	Product Code	Description	Color Availability
Soffit	SAS12316	Endurance T4 Soffit Solid	J0/04 White
	LCAS12316	Endurance T4 Soffit Center Vent	620 Autumn Tan
	LFAS12316	Endurance T4 Soffit Full Vent	625 Khaki Brown
	F438425	3/8" J-Channel	A5 Monterey Taupe
			53 Navajo Beige (Almond)
			A8 Sail Cloth
			297 Sandstone Beige
			581 Woodstock Brown

7" Rainware Program

Product Code/Description

Color Availability

Gutter Coil

GC17875

.027" X 17.875"**Gutter Coil**

- Nominal Thickness: .027
- 450 Lbs./Roll
- 2 Ro/Pallet

30° White
(Medium Gloss)
80° White
(High Gloss)
Black
Almond
Cameo
Classic Cream
Dark Bronze
Desert Sand
Linen
Montana Suede
Musket Brown
Pebblestone Clay
Royal Brown
Sandtone
Wicker

Gutter Accessories

ISM7

7" Inside Strip Miter

OSM7

7" Outside Strip Miter

- 20 Pcs./Ctn.
- 4.2 Lbs./Ctn.

EC7L

7" Left End Cap

EC7R

7" Right End Cap

- 50 Pcs./Ctn.
- 4.5 Lbs./Ctn.

Downspouts, Elbows and Accessories

DS4X5

4" x 5" x 10'**Downspout**

- Nominal Thickness: .027
- 6 Pcs./Ctn.
- 35 Lbs./Ctn.

E4X5A

4" x 5" A Elbow

E4X5B

4" x 5" B Elbow

- Nominal Thickness: .027
- 9 Pcs./Ctn.
- 7 Lbs./Ctn.

AM7ZIP 01

7" Zip Hangers

- 250 Pcs./Ctn.
- 30 Lbs./Ctn.

AM7HID 01

7" Hidden Hangers

- 350 Pcs./Ctn.
- 18 Lbs./Ctn.

OT4X5 01

4" x 5" Outlet Tube

- 10 Pcs./Ctn.
- 1 Lbs./Ctn.

SN7200S 00

7" Leaf Relief Combo Hanger w/Screws

- 7' 6" Length
- 200 Screws/Ctn.
- 24 Pcs./Ctn.
- 47 Lbs./Ctn.

Round Downspout Program

 Product Code/Description

 Color Availability

Downspout, Elbow, Offsets

30° White
(Medium Gloss)
Black
Dark Bronze

DSR4

4" Smooth Round Downspout

- Nominal Thickness: .024
- 5 Pcs./Ctn.
- 21 Lbs./Ctn.



ESR4

4" Smooth Round Elbow 75°

- Nominal Thickness: .024
- 20 Pcs./Ctn.
- 11 Lbs./Ctn.



OSR420

4" Smooth Round - 2' Offset

- Nominal Thickness: .024
- 10 Pcs./Ctn.
- 5 Lbs./Ctn.

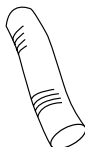

OSR440

4" Smooth Round - 4' Offset

- Nominal Thickness: .024
- 10 Pcs./Ctn.
- 6 Lbs./Ctn.

Envoy® Sectional Gutter

5" Gutter and Accessories

Product Code/Description

Color Availability

OG16A

**Envoy Sectional
5" OG Gutter**

- Nominal Thickness: .032
- Length: 16'
- 10 Pcs./Ctn.
- 160'/Ctn.
- 80 Lbs./Ctn.

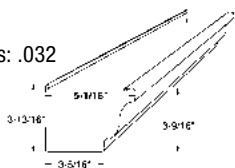

80° White
(High Gloss)
Almond
Desert Sand
Evergreen
Musket Brown
Pebblestone Clay
Sandtone
Terra Bronze
Victorian Grey

OG21A

**Envoy Sectional
5" OG Gutter**

- Nominal Thickness: .032
- Length: 21'
- 10 Pcs./Ctn.
- 210'/Ctn.
- 105 Lbs./Ctn.

OG26

**Envoy Sectional
5" OG Gutter**

- Nominal Thickness: .032
- Length: 26'
- 6 Pcs./Ctn.
- 156'/Ctn.
- 81 Lbs./Ctn.

OG33A

**Envoy Sectional
5" OG Gutter**

- Nominal Thickness: .032
- Length: 33'
- 6 Pcs./Ctn.
- 198'/Ctn.
- 103 Lbs./Ctn.

OG37A

**Envoy Sectional
5" OG Gutter**

- Nominal Thickness: .032
- Length: 37'
- 6 Pcs./Ctn.
- 222'/Ctn.
- 115 Lbs./Ctn.

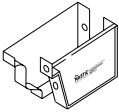
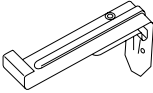
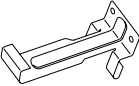
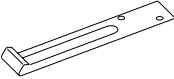

Envoy® Sectional Gutter

5" Gutter Accessories

Product Code/Description	Color Availability	
<p>OG155</p> <p>5" End Caps</p> <ul style="list-style-type: none"> Nominal Thickness: .024 25 R and 25 L 25 Sets/Ctn. 50 Pcs./Ctn. 3.3 Lbs./Ctn. 		<p>80° White (High Gloss)</p> <p>Almond</p> <p>Desert Sand</p> <p>Evergreen</p> <p>Musket Brown</p> <p>Pebblestone Gray</p> <p>Sandtone</p> <p>Terra Bronze</p> <p>Victorian Grey</p>
<p>OG25</p> <p>Neoprene Expansion Joint</p> <ul style="list-style-type: none"> 12 Pcs./Ctn. 4 Lbs./Ctn. 		
<p>OG91</p> <p>Snug-Fit Hanger</p> <ul style="list-style-type: none"> Nominal Thickness: .081 100 Pcs./Ctn. 11.2 Lbs./Ctn. 		
<p>OG101</p> <p>Combination Hanger</p> <ul style="list-style-type: none"> Nominal Thickness: .081 100 Pcs./Ctn. 8.4 Lbs./Ctn. 		
<p>OG111</p> <p>Strap Hanger</p> <ul style="list-style-type: none"> Nominal Thickness: .081 100 Pcs./Ctn. 9.6 Lbs./Ctn. 		

Envoy® Sectional Gutter

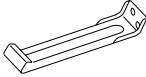
5" Gutter Accessories

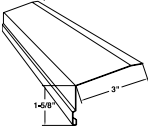
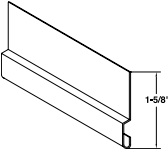
Product Code/Description	Color Availability
<p>OG12R1 Bar Hanger</p> <ul style="list-style-type: none"> Nominal Thickness: .081 100 Pcs./Ctn. 7.4 Lbs./Ctn. 	<p>Mill</p> 
<p>OG131 Roof Hanger</p> <ul style="list-style-type: none"> Nominal Thickness: .062 100 Pcs./Ctn. 13 Lbs./Ctn. 	<p>Mill</p> 
<p>OG141 Combination Strap Hanger</p> <ul style="list-style-type: none"> Nominal Thickness: .081 100 Pcs./Ctn. 12 Lbs./Ctn. 	<p>Mill</p> 
<p>RT312 Roof Apron, Rectangular</p> <ul style="list-style-type: none"> Nominal Thickness: .032 Length: 12' 20 Pcs./Ctn. 320'/Ctn. 47 Lbs./Ctn. 	<p>80° White (High Gloss) Almond Desert Sand Evergreen Musket Brown Pebblestone Clay Sandtone Terra Bronze Victorian Grey</p> 
<p>RT412 Fascia Apron, Rectangular</p> <ul style="list-style-type: none"> Nominal Thickness: .032 Length: 12' 20 Pcs./Ctn. 240'/Ctn. 15 Lbs./Ctn. 	<p>80° White (High Gloss) Almond Desert Sand Evergreen Musket Brown Pebblestone Clay Sandtone Terra Bronze Victorian Grey</p> 

Envoy® Sectional Gutter

6" Gutter and Accessories

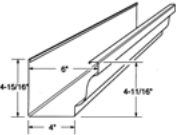
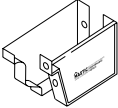
Product Code/Description	Color Availability
<p>OG21A6 Envoy Sectional 6" OG Gutter</p> <ul style="list-style-type: none"> Nominal Thickness: .032 Length: 21' 6 Pcs./Ctn. 126'/Ctn. 79 Lbs./Ctn. 	<p>80° White (High Gloss) Almond Desert Sand Evergreen Musket Brown Pebblestone Clay Sandtone Terra Bronze Victorian Grey</p>
<p>OG37A6 Envoy Sectional 6" OG Gutter</p> <ul style="list-style-type: none"> Nominal Thickness: .032 Length: 37' 4 Pcs./Ctn. 148'/Ctn. 95 Lbs./Ctn. 	
<p>OG1565 6" End Caps</p> <ul style="list-style-type: none"> Nominal Thickness: .024 25 Sets/Ctn. 50 Pcs./Ctn. 4.5 Lbs./Ctn. 	<p>80° White (High Gloss) Almond Desert Sand Evergreen Musket Brown Pebblestone Clay Sandtone Terra Bronze Victorian Grey</p>

Envoy® Sectional Gutter

6" Gutter and Accessories

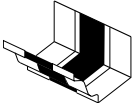
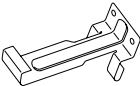
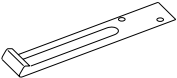
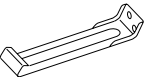
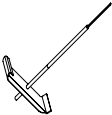

Product Code/Description	Color Availability
OG256 Neoprene Expansion Joint <ul style="list-style-type: none"> • 12 Pcs./Ctn. • 5 Lbs./Ctn. 	 Mill
OG1061 Combination Hanger <ul style="list-style-type: none"> • Nominal Thickness: .081 • 100 Pcs./Ctn. • 9.4 Lbs./Ctn. 	 Mill
OG1161 Strap Hanger <ul style="list-style-type: none"> • Nominal Thickness: .081 • 100 Pcs./Ctn. • 11 Lbs./Ctn. 	 Mill
OG12R61 Bar Hanger <ul style="list-style-type: none"> • Nominal Thickness: .081 • 100 Pcs./Ctn. • 8.3 Lbs./Ctn. 	 Mill
OG1361 Roof Hanger <ul style="list-style-type: none"> • Nominal Thickness: .062 • 100 Pcs./Ctn. • 13 Lbs./Ctn. 	 Mill

Envoy® Sectional Gutter

Downspouts and Accessories

Product Code/Description	Color Availability
<p>RT34 3" x 4" Rectangular Corrugated Downspout</p> <ul style="list-style-type: none"> Nominal Thickness: .024 Length: 10' 10 Pcs./Ctn. 100'/Ctn. 43 Lbs./Ctn. 	<p>30° White (Medium Gloss) 80° White (High Gloss) Almond Desert Sand Evergreen Musket Brown Pebblestone Clay Sandtone Terra Bronze Victorian Grey</p>
<p>RTA74 3" x 4" Style "A" Rectangular Elbow</p> <ul style="list-style-type: none"> Nominal Thickness: .024 Degree: 75° 20 Pcs./Ctn. 9 Lbs./Ctn. 	
<p>RTB74 3" x 4" Style "B" Rectangular Elbow</p> <ul style="list-style-type: none"> Nominal Thickness: .024 Degree: 75° 20 Pcs./Ctn. 10 Lbs./Ctn. 	
<p>RTA3 Downspout Clip</p> <ul style="list-style-type: none"> (For 3" x 4" Downspout) Nominal Thickness: .024 100 Pcs./Ctn. 2.8 Lbs./Ctn. 	<p>30° White (Medium Gloss) 80° White (High Gloss) Black Almond Cameo Classic Cream Dark Bronze Desert Sand Evergreen Linen Musket Brown Pebblestone Clay Royal Brown Sandtone Terra Bronze Victorian Grey Wicker</p>

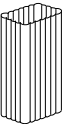
Envoy® Sectional Gutter Downspouts and Accessories

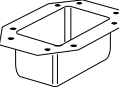
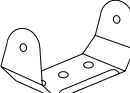
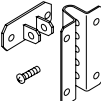
Product Code/Description	Color Availability
<p>RT2 2" x 3" Rectangular Corrugated Downspout <ul style="list-style-type: none"> Nominal Thickness: .024 Length: 10' • 100'/Ctn. 10 Pcs./Ctn. • 33 Lbs./Ctn. </p>	 <ul style="list-style-type: none"> 30° White (Medium Gloss) 80° White (High Gloss) Almond Desert Sand Evergreen Musket Brown Pebblestone Clay Sandtone Terra Bronze Victorian Grey
<p>2" x 3" Style "A" Rectangular Elbow RTA4 (80° White High Gloss Only) <ul style="list-style-type: none"> Nominal Thickness: .024 • 30 Pcs./Ctn. Degree: 45° • 8 Lbs./Ctn. </p>	
<p>RTA7 <ul style="list-style-type: none"> Nominal Thickness: .024 • 30 Pcs./Ctn. Degree: 75° • 9 Lbs./Ctn. </p>	
<p>RTB7 2" x 3" Style "B" Rectangular Elbow <ul style="list-style-type: none"> Nominal Thickness: .024 • 30 Pcs./Ctn. Degree: 75° • 9 Lbs./Ctn. </p>	
<p>ROT2X3 2" x 3" Rectangular Eave Tube <ul style="list-style-type: none"> Nominal Thickness: .024 30 Pcs./Ctn. 1.9 Lbs./Ctn. </p>	<p>Mill</p> 
<p>RTA2 Downspout Clip <ul style="list-style-type: none"> (For 2" x 3" Downspout) Nominal Thickness: .024 100 Pcs./Ctn. 1.7 Lbs./Ctn. </p>	 <ul style="list-style-type: none"> 30° White (Medium Gloss) 80° White (High Gloss) Black Almond Cameo Clasic Cream Dark Bronze Desert Sand Evergreen Linen Musket Brown Pebblestone Clay Royal Brown Sandtone Terra Bronze Victorian Grey Wicker
<p>RT235 Downspout Anchor Clip with Screw <ul style="list-style-type: none"> 50 Sets/Ctn. 3.2 Lbs./Ctn. </p>	<p>Mill</p> 

PLY GEM PERFORMANCE METALS

Leaf Relief® 5"

Gutter Protection Systems

 Product Code/Description

 Color Availability

D11500

33 Black

DuoPro 5" Dual Layer Microfiltration - Continuous Hanger

- Nominal Thickness: .019
- Length: 7' 6"
- 24 Pcs./Ctn.
- 180'/Ctn.
- 47 Lbs./Ctn.

Note: 200 screws/Ctn. Use Leaf Relief DuoPro 5" Dual Layer Universal Corner or Access Panel Kit UA11500.

UA11500

DuoPro 5" Dual Layer Microfiltration Universal Inside/Outside Corner or Access Panel Kit

- Nominal Thickness: .019
- 10 Corners or 20 Access Panels/Ctn
- 5 Lbs./Ctn.

Note: Use with D11500 DuoPro 5" Dual Layer Microfiltration Continuous Hanger. Universal Inside/Outside/Access Panel functions as either one corner or two Access Panels.

Leaf Relief



SN5200S

00 Mill Finish

5" Continuous Hanger

- Nominal Thickness: .019
- Length: 7' 6"
- 48 Pcs./Ctn.
- 360'/Ctn.
- 59.4 Lbs./Ctn.

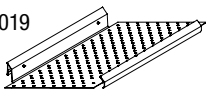

Note: 300 screws/Ctn. Use Leaf Relief corner kits OC5220/IC5220.

APSN52

5" Leaf Relief Access Panel

- Nominal Thickness: .019
- Length: 1' 6"
- 20 Pcs./Ctn.
- 30'/Ctn.
- 5.8 Lbs./Ctn.

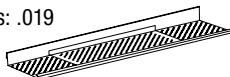

Leaf Relief CH
& DuoPro on
new gutters



Leaf Relief® 5"

Gutter Protection Systems

Product Code/Description

Color Availability

SN5200BG

5" Box Gutter Continuous Hanger

- Length: 7' 6"
- 360'/Ctn.
- 63 Lbs./Ctn.
- 300 screws included.

Note: Use Leaf Relief corner kit
UA5200BG Universal Inside/
Outside Corner Access Panel.

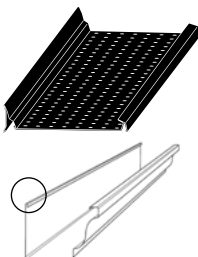

33 Black

UA5200BG

5" Box Gutter Continuous Hanger Universal Inside/Outside Corner/Access Panel Kit

- 10 Corners or 20 Access Panels/Ctn.
- 4 Lbs./Ctn.

TP5300

5" Classic

- Nominal Thickness: .019
- Length: 10'
- 32 Pcs./Ctn.
- 320'/Ctn.
- 48.6 Lbs./Ctn.



00 Mill Finish

TP53ZIP

5" Zip

- Nominal Thickness: .019
- Length: 10'
- 32 Pcs./Ctn.
- 320'/Ctn.
- 51.8 Lbs./Ctn.

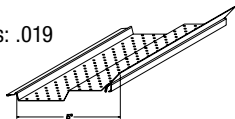

TP5100Q

5" Adjustable

- Nominal Thickness: .019
- Length: 7' 6"
- 16 Pcs./Ctn.
- 120'/Ctn.
- 22 Lbs./Ctn.

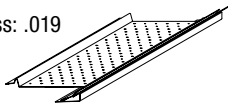

**Installing classic
Leaf Relief on
existing gutters**



Leaf Relief® 5"

Gutter Protection Systems

 Product Code/Description

 Color Availability

TPC5100

0C Copper

5" Adjustable Copper

- Nominal Thickness: .017
- Length: 7' 6"
- 16 Pcs./Ctn.
- 120'/Ctn.
- 71.6 Lbs./Ctn.
- 200 Copper screws included.

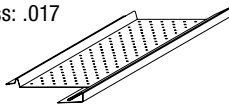

Use only with K or OG-style copper gutters.

*Special order. One Carton Minimum. Call for price and lead time.

HR5400

00 Mill Finish

5" Half-Round

- Nominal Thickness: .024
- Length: 7' 6"
- 16 Pcs./Ctn.
- 120'/Ctn. • 22.6 Lbs./Ctn.



HRC5400

0C Copper

5" Half Round Copper

- Nominal Thickness: .017
- Length: 7' 6"
- 16 Pcs./Ctn.
- 120'/Ctn.
- 56.5 Lbs./Ctn.
- 200 Copper screws included.



Use only with 5" Half-Round copper gutters.

*Special order. One Carton Minimum. Call for price and lead time.

OC5220

00 Mill Finish

5" Outside Corners

- Nominal Thickness: .019
- 20 Complete Corners/Ctn.
- 3.4 Lbs./Ctn.

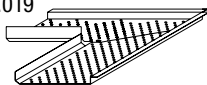

Use with SN5200S, TP5100Q, TP5300, TP53ZIP

IC5220

5" Inside Corners

- Nominal Thickness: .019
- 20 Complete Corners/Ctn.
- 3.4 Lbs./Ctn.

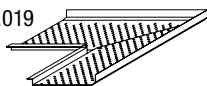

Use with SN5200S, TP5100Q, TP5300, TP53ZIP

Leaf Relief® 6"

Gutter Protection Systems

 Product Code/Description

 Color Availability

D11600

33 Black

DuoPro 6" Dual Layer Microfiltration - Continuous Hanger

- Nominal Thickness: .019
- Length: 7' 6"
- 24 Pcs./Ctn.
- 180'/Ctn.
- 200 screws included
- 54 Lbs./Ctn.

Note: Use Leaf Relief DuoPro 6" Dual Layer Universal Corner or Access Panel Kit UA11600. Universal Inside/Outside/Access Panel functions as either one corner or two Access Panels.

UA11600

DuoPro 6" Dual Layer Microfiltration Universal Inside/Outside Corner or Access Panel Kit

- Nominal Thickness: .019
- 10 Corners or 20 Access Panels/Ctn
- No screws included
- 5 Lbs./Ctn.

Note: Use with D11600 DuoPro 6" Dual Layer Microfiltration Continuous Hanger. Universal Inside/Outside/Access Panel functions as either one corner or two Access Panels.

SN6200S

00 Mill Finish

6" Continuous Hanger

- Nominal Thickness: .019
- Length: 7' 6"
- 34 Pcs./Ctn.
- 255'/Ctn.
- 49.4 Lbs./Ctn.

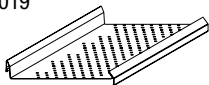

Note: 300 screws/Ctn. Use Leaf Relief corner kits 0C6220/1C6220

APSN62

00 Mill Finish

6" Leaf Relief Access Panel

- Nominal Thickness: .019
- Length: 1' 6"
- 20 Pcs./Ctn.
- 30'/Ctn.
- 6.6 Lbs./Ctn.

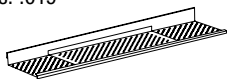

**Leaf Relief CH
& DuoPro on
new gutters**



Leaf Relief® 6"

Gutter Protection Systems

Product Code/Description

Color Availability

SN6200BG

33 Black

6" Box Gutter Continuous Hanger

- Nominal Thickness: .019
- Length: 7' 5"
- 34 Pcs./Ctn.
- 255'/Ctn.
- 300 screws included
- 71 Lbs./Ctn.

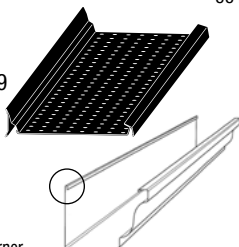

Note: use Leaf Relief Universal Corner or Access Panel Kit UA6200BG Universal Inside/Outside/Access Panel. Universal Inside/Outside/Access Panel either functions as one corner or two Access Panels.

UA6200BG

6" Box Gutter Universal Inside/Outside Corner or Access Panel Kit

- Nominal Thickness: .019
- 10 Corners or 20 Access Panels/Ctn
- No screws included
- 4 Lbs./Ctn.

Note: use with SN6200BG 6" Box Gutter Continuous Hanger.

TP6300

00 No Color

6" Classic

- Nominal Thickness: .019
- Length: 10'
- 32 Pcs./Ctn.
- 320'/Ctn.
- 55.4 Lbs./Ctn.

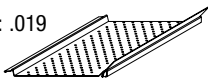

TP63ZIP

6" Zip

- Nominal Thickness: .019
- Length: 10'
- 32 Pcs./Ctn.
- 320'/Ctn.
- 57.6 Lbs./Ctn.

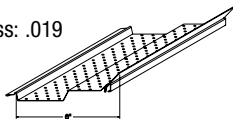

(For use over OG1061, OG12R61, zip hangers)

Leaf Relief® 6"

Gutter Protection Systems

 Product Code/Description

 Color Availability

TPC6100

00 Copper

6" Adjustable Copper

- Nominal Thickness: .017
- Length: 7' 6"
- 16 Pcs./Ctn.
- 120'/Ctn.
- 75.0 Lbs./Ctn.
- 200 Copper screws included.

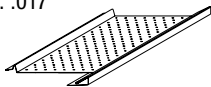

Use only with K or OG-style copper gutters.

* Special Order. One Carton Minimum. Call for price and lead time.

HR6400

00 Mill Finish

6" Half Round

- Nominal Thickness: .024
- Length: 7' 6"
- 16 Pcs./Ctn.
- 120'/Ctn.
- 25.4 Lbs./Ctn.



HRC6400

00 Copper

6" Half Round Copper

- Nominal Thickness: .017
- Length: 7' 6"
- 16 Pcs./Ctn.
- 120'/Ctn.
- 63.0 Lbs./Ctn.
- 200 Copper screws included.



Use only with 6" Half-Round copper gutters.

OC6220

00 Mill Finish

6" Leaf Relief Outside Corners

- Nominal Thickness: .019
- 20 Complete Corners/Ctn.
- 3.8 Lbs./Ctn.

Use with: SN6200S, TP6300

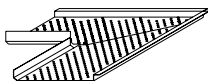

IC6220

6" Leaf Relief Inside Corners

- Nominal Thickness: .019
- 20 Complete Corners/Ctn.
- 3.8 Lbs./Ctn.

Use with: SN6200S, TP6300

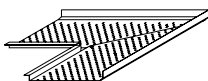

Leaf Relief®

Gutter Protection Systems

Product Code/Description	Color Availability
--------------------------	--------------------

SN7200S

00 No Color

7" Leaf Relief Continuous Hanger w/Screws

- 7' 6" Length
- 200 Screws/Ctn.
- 24 Pcs./Ctn.
- 47 Lbs./Ctn.

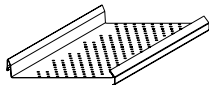

SC9X150

#9 x 1-1/2" Hex-Head Coated Screw with Gasket

- 1000/Ctn.
- 100/Pkg.
- 10 Pkg./Ctn.
- 11.5 Lbs./Ctn.



(For use with SN5200S, SN6200S, and SN7200S Systems)

SQ6X038

Mill Finish

#6 x 3/8" Stainless Steel Screw Pan Head with Square Drive Slot

- 1000/Ctn.
- 100/Pkg.
- 10 Pkg./Ctn.
- 2 Lbs./Ctn

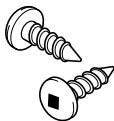

(For use with TP5100Q , TP5300, HR5400, HR6400, and TP6300 Systems)

Leaf Logic™ Gutter Protection Systems

Product Code/Description

LL510

5" Rippled Plate

- Nominal
Thickness: .015
- Length: 10'
- 30 Pcs./Ctn.
- 300'/Ctn.
- 30 Lbs./Ctn.

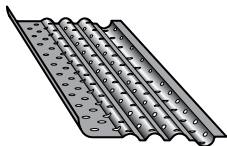

Color Availability

04 White
00 Mill Finish
JS Dark Bronze

LL610

6" Rippled Plate

- Nominal
Thickness: .015
- Length: 10'
- 30 Pcs./Ctn.
- 300'/Ctn.
- 35 Lbs./Ctn.

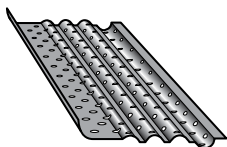

Leaf Smart™

Gutter Protection Systems

Product Code/Description

LS54

5" Steel Mesh

- Nominal
Thickness: .032
- Length: 4'
- 25 Pcs./Ctn.
- 100'/Ctn.
- 26 Lbs./Ctn.

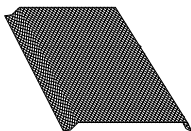

Color Availability

00 Mill Finish

LS64

6" Steel Mesh

- Nominal
Thickness: .032
- Length: 4'
- 25 Pcs./Ctn.
- 100'/Ctn.
- 28 Lbs./Ctn.

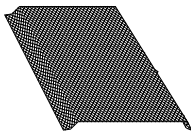

Roofing Accessories

T-Drip

Product Code	Description	Face Lgth	Top Lgth	Part Lgth	Material	Finish	Nominal Thickness/ Gauge	Pcs/ Ctn	Lbs/ Ctn
TD1029L	T-Drip 1x2-7/8 Light	1"	2-7/8"	10'	Aluminum	Alumalure 2000	0.013	25	15.8
Available Colors: White 04, Black 33, Musket Brown 59									
TD1029	T-Drip 1x2-7/8	1"	2-7/8"	10'	Aluminum	Alumalure 2000	0.016	25	19.2
Available Colors: White 04, Pebblestone Clay 52									
TD1029S	T-Drip 1x2-7/8 Galvanized	1"	2-7/8"	10'	Galvanized Steel	Polyester	0.016	25	51.1
Available Colors: Royal Brown 62									
TD1529	T-Drip 1-1/2x2-7/8	1-1/2"	2-7/8"	10'	Aluminum	Alumalure 2000	0.016	25	21.6
Available Colors: White 04, Black 33, Pebblestone Clay 52, Royal Brown 62									
TD1529H	T-Drip 1-1/2x2-7/8 Heavy	1-1/2"	2-7/8"	10'	Aluminum	Alumalure 2000	0.019	25	25.2
Available Colors: White 04, Black 33, Almond 53, Dark Bronze JS, Desert Sand 22, Musket Brown 59, Pebblestone Clay 52, Royal Brown 62, Terra Bronze 34, Wicker A7									
TD1529H12	T-Drip 1-1/2x2-7/8x12' Heavy	1-1/2"	2-7/8"	12'	Aluminum	Alumalure 2000	0.019	25	30.3
Available Colors: White 04, Black 33, Almond 53, Cameo 31, Charcoal Grey 80, Dark Bronze JS, Desert Sand 22, Evergreen 70, Linen 44, Musket Brown 59, Pebblestone Clay 52, Royal Brown 62, Sandtone 39, Terra Bronze 34, Wicker A7									
TD1829	T-Drip 1-3/4x2-7/8	1-3/4"	2-7/8"	10'	Aluminum	Alumalure 2000	0.016	25	22.5
Available Colors: White 04, Black 33, Almond 53, Dark Bronze JS, Musket Brown 59, Pebblestone Clay 52, Royal Brown 62, Wicker A7, A5 Monterey Taupe									
TD1829H	T-Drip 1-3/4x2-7/8 Heavy	1-3/4"	2-7/8"	10'	Aluminum	Alumalure 2000	0.019	25	26.4
Available Colors: Almond 53, Cameo 31, Charcoal Grey 80, Dark Bronze JS, Desert Sand 22, Evergreen 70, Musket Brown 59, Pebblestone Clay 52, Royal Brown 62, Terra Bronze 34, Wicker A7, White 04, Black 33, Monterey Taupe A5									
TD2029H	T-Drip 2x2-7/8 Heavy	2"	2-7/8"	10'	Aluminum	Alumalure 2000	0.019	25	28.3
Available Colors: White 04									

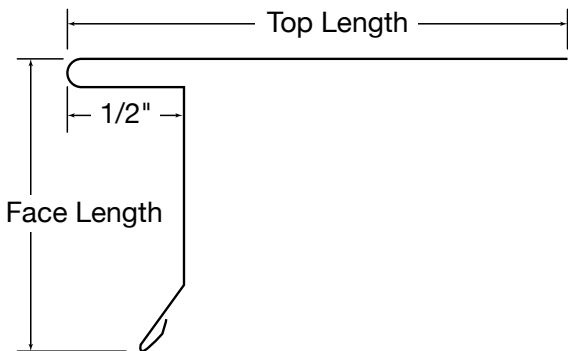

Roofing Accessories

F-Drip

Product Code	Description	Face Lgth	Top Lgth	Part Lgth	Material	Finish	Nominal Thickness/ Gauge	Pcs/ Ctn	Lbs/ Ctn
FD1060H	F-Drip 1x6 Heavy	1"	6"	10'	Aluminum	Alumalure 2000	0.019	25	35.5
Available Colors: White 04									
FD202012	F-Drip 2x2	2"	2"	12'	Aluminum	Alumalure 2000	0.016	25	23
Available Colors: White 04, Black 33, Musket Brown 59, Pebblestone Clay 52									
FD2020H12	F-Drip 2x2x12' Heavy	2"	2"	12'	Aluminum	Alumalure 2000	0.019	25	27
Available Colors: White 04									
FD2028	F-Drip 2x2-3/4	2"	2-3/4"	10'	Aluminum	Alumalure 2000	0.016	25	22.5
Available Colors: White 04									
FD2028H	F-Drip 2x2-3/4 Heavy	2"	2-3/4"	10'	Aluminum	Alumalure 2000	0.019	25	26.5
Available Colors: White 04, Almond 53, Charcoal Grey 80, Desert Sand 22, Linen 44, Musket Brown 59, Sandtone 39, Victorian Grey 36									
FD2028S	F-Drip 2x2-3/4 Galvanized	2"	2-3/4"	10'	Galvanized Steel	Polyester	0.016	25	59.9
Available Colors: Mill 00, White 04, Black 33, Almond 53, Pebblestone Clay 52, Royal Brown 62, Terra Bronze 34									

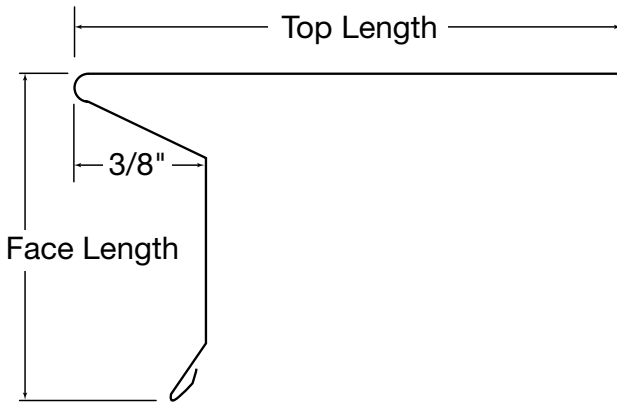

PLY GEM PERFORMANCE METALS

Roofing Accessories

C-Drip

Product Code	Description	Face Lgth	Top Lgth	Bottom Lgth	Part Lgth	Material	Finish	Nominal Thickness/ Gauge	Pcs/ Ctn	Lbs/ Ctn
CD1028H	C-Drip 1x2-3/4 Heavy	1"	2-3/4"	1-1/8"	10'	Aluminum	Alumalure 2000	0.019	25	26.4

Available Colors: White 04

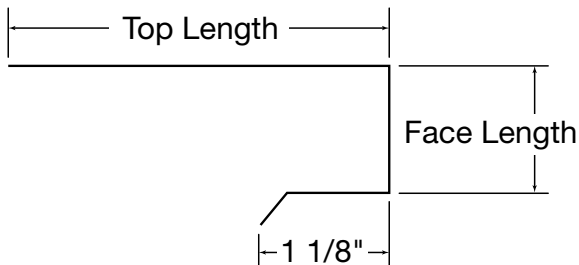

Roofing Accessories

Square Drip / Gutter Apron

Product Code	Description	Face Lgth	Top Lgth	Part Lgth	Material	Finish	Nominal Thickness/ Gauge	Pcs/ Ctn	Lbs/ Ctn
SD1515H	Sq Drip 1-1/2x1-1/2 Heavy	1-1/2"	1-1/2"	10'	Aluminum	Alumalure 2000	0.019	25	20.5

Available Colors: White 04

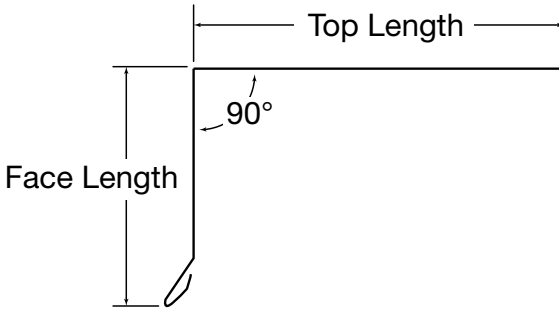

Product Code	Description	Face Lgth	Top Lgth	Part Lgth	Material	Finish	Nominal Thickness/ Gauge	Pcs/ Ctn	Lbs/ Ctn
GA2029H	Apron 2x2-7/8" Heavy	2"	2-7/8"	10'	Aluminum	Alumalure 2000	0.019	25	25.2

Available Colors: White 04, Black 33, Almond 53, Dark Bronze JS, Musket Brown 59, Pebblestone Clay 52, Royal Brown 62, Terra Bronze 34, Wicker A7

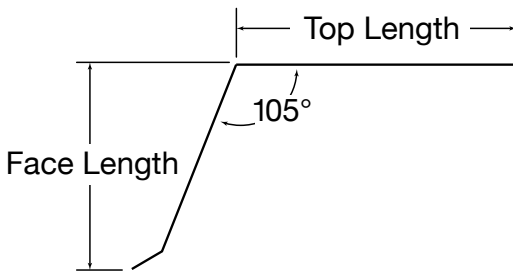

Roofing Accessories

Quick Drip / Gravel Stop

Product Code	Description	Face Lgth	Top Lgth	Part Lgth	Material	Finish	Nominal Thickness/ Gauge	Pcs/ Ctn	Lbs/ Ctn
QD2410H12	Quick Drip 2-7/16x1x12' Heavy	2-7/16"	1"	12'	Aluminum	Alumalure 2000	0.019	25	20.5

Available Colors: White 04, Black 33, Almond 53, Cameo 31

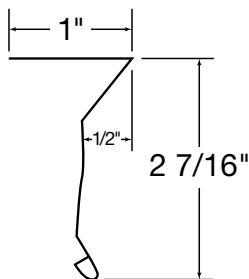

Product Code	Description	Face Lgth	Top Lgth	Part Lgth	Material	Finish	Nominal Thickness/ Gauge	Pcs/ Ctn	Lbs/ Ctn
GS4040XH	Gravel Stop 4x4 Extra Heavy	4"	4"	10'	Aluminum	Alumalure 2000	0.024	25	25.2

Available Colors: White 04, Black 33, Dark Bronze JS, Musket Brown 59, Pebblestone Clay 52, Royal Brown 62, Terra Bronze 34, A5 Monterey Taupe

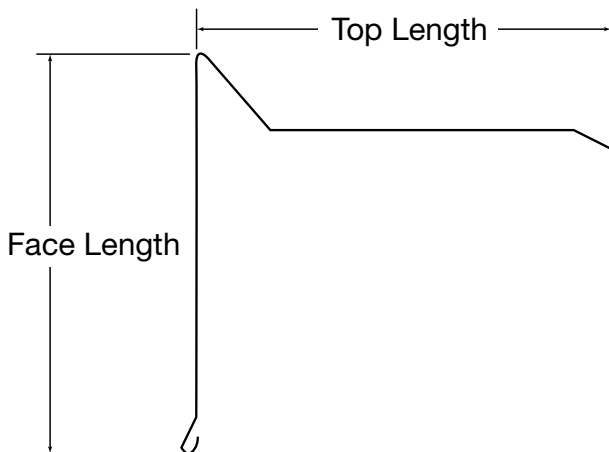

BuildReady Trim

5/8 Trim Board (5/8" actual)

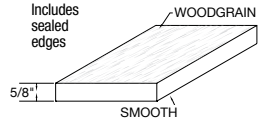
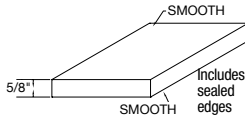

(Protective Film Top Side)

18' Lengths	Smooth	Woodgrain	Selling UOM	Pieces/ Selling Unit	Skid Length (Feet)	Skid Width (Feet)	Skid Height (Inches)
5/8" x 4	27845001	27848001	Unit	130	18	4	11.5
5/8" x 6	27845002	27848002	Unit	80	18	4	11.5
5/8" x 8	27845003	27848003	Unit	60	18	4	11.5
5/8" x 10	27845004	27848004	Unit	50	18	4	11.5
5/8" x 12	27845005	27848005	Unit	40	18	4	11.5
5/8" x 16	27845078	27848078	Unit	30	18	4	11.5

4/4 Trim Board (3/4" actual)

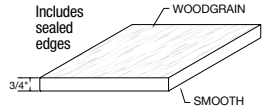
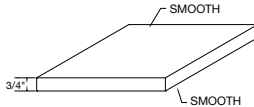

(Protective Film Top Side)

12' Offering	Smooth	Woodgrain	Selling UOM	Pieces/ Selling Unit	Skid Length (Feet)	Skid Width (Feet)	Skid Height (Inches)
1 x 4	27845146	27848146	Unit	104	12	4	11.1
1 x 6	27845147	27848147	Unit	64	12	4	11.1
1 x 8	27845148	27848148	Unit	48	12	4	11.1
1 x 10	27845149	27848149	Unit	40	12	4	11.1
1 x 12	27845150	27848150	Unit	32	12	4	11.1

18' Offering	Smooth	Woodgrain	Selling UOM	Pieces/ Selling Unit	Skid Length (Feet)	Skid Width (Feet)	Skid Height (Inches)
1 x 4	27845006	27848006	Unit	104	18	4	11.1
1 x 6	27845009	27848009	Unit	64	18	4	11.1
1 x 8	27845010	27848010	Unit	48	18	4	11.1
1 x 10	27845011	27848011	Unit	40	18	4	11.1
1 x 12	27845012	27848012	Unit	32	18	4	11.1
1 x 16	27845377	27848377	Unit	24	18	4	11.1

20' Offering	Smooth	Woodgrain	Selling UOM	Pieces/ Selling Unit	Skid Length (Feet)	Skid Width (Feet)	Skid Height (Inches)
1 x 3	27845519	27848519	Unit	114	20	4	9.6
1 x 4	27845513	27848513	Unit	104	20	4	11.1
1 x 6	27845514	27848514	Unit	64	20	4	11.1
1 x 8	27845515	27848515	Unit	48	20	4	11.1
1 x 10	27845516	27848516	Unit	40	20	4	11.1
1 x 12	27845517	27848517	Unit	32	20	4	11.1
1 x 16	27845518	27848518	Unit	24	20	4	11.1

Trim Board measurements are nominal. All Sheet and 5/8" Trim Board measurements are actual. Please see our website for more detailed information.

BuildReady

Trim

5/4

Trim Board

(1" actual)

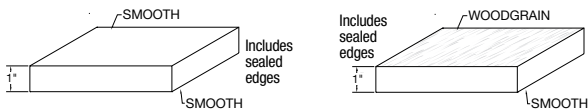

(Protective Film Top Side)

12' Offering	Smooth	Woodgrain	Selling UOM	Pieces/Selling Unit	Skid Length (Feet)	Skid Width (Feet)	Skid Height (Inches)
5/4 x 4	27845156	27848156	Unit	78	12	4	11
5/4 x 6	27845157	27848157	Unit	48	12	4	11
5/4 x 8	27845158	27848158	Unit	36	12	4	11
5/4 x 10	27845187	27848187	Unit	30	12	4	11
5/4 x 12	27845208	27848208	Unit	24	12	4	11

18' Offering	Smooth	Woodgrain	Selling UOM	Pieces/Selling Unit	Skid Length (Feet)	Skid Width (Feet)	Skid Height (Inches)
5/4 x 4	27845013	27848013	Unit	78	18	4	11
5/4 x 5	27845503	27848503	Unit	70	18	4	12
5/4 x 6	27845015	27848015	Unit	48	18	4	11
5/4 x 8	27845016	27848016	Unit	36	18	4	11
5/4 x 10	27845017	27848017	Unit	30	18	4	11
5/4 x 12	27845018	27848018	Unit	24	18	4	11
5/4 x 16	27845527	27848527	Unit	18	18	4	11

20' Offering	Smooth	Woodgrain	Selling UOM	Pieces/Selling Unit	Skid Length (Feet)	Skid Width (Feet)	Skid Height (Inches)
5/4 x 4	27845072	27848072	Unit	78	20	4	11
5/4 x 6	27845074	27848074	Unit	48	20	4	11
5/4 x 8	27845075	27848075	Unit	36	20	4	11
5/4 x 10	27845076	27848076	Unit	30	20	4	11
5/4 x 12	27845077	27848077	Unit	24	20	4	11
5/4 x 16	27845405	27848405	Unit	18	20	4	11



**Installing
PVC trim**



**PVC trim
offerings and
accessories**

Trim Board measurements are nominal. All Sheet and 5/8" Trim Board measurements are actual. Please see our website for more detailed information.

BuildReady Accessories

Specialty Offerings

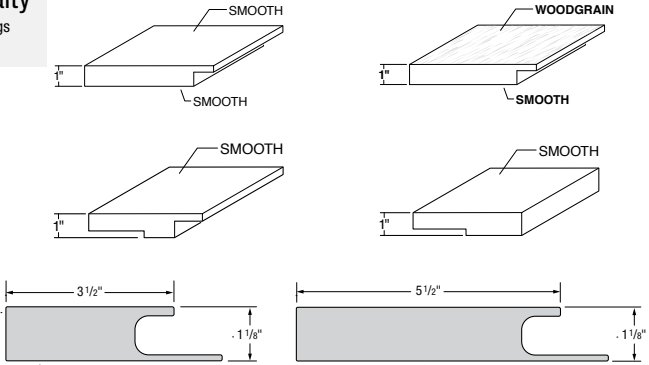

18' Offering	Smooth	Woodgrain	Selling UOM	Pieces/Selling Unit	Skid Length (Feet)	Skid Width (Feet)	Skid Height (Inches)
5/4 x 4 w/J-Pocket	27845528-P	27848528-P	Unit	78	18	4	11.25
			Ply Pak	3	non-skid	non-skid	non-skid
5/4 x 4 Flange	27845529-P	n/a	Unit	78	18	4	11.25
			Ply Pak	2	non-skid	non-skid	non-skid
5/4 x 4 Flange w/J-Pocket	27845530-P	n/a	Unit	78	18	4	11.25
			Ply Pak	2	non-skid	non-skid	non-skid
5/4 x 5 w/J-Pocket	27845531-P	27848531-P	Unit	70	18	4	12.25
			Ply Pak	2	non-skid	non-skid	non-skid
5/4 x 6 w/J-Pocket	27845532-P	27848532-P	Unit	48	18	4	9.25
			Ply Pak	2	non-skid	non-skid	non-skid
1 x 4 J-Pocket Casing w/nail fin (16' length)	27845569-MB	n/a	Bundle	4	non-skid	non-skid	non-skid
1 x 6 J-Pocket Casing w/nail fin (12' length)	27845570-MB	n/a	Bundle	4	non-skid	non-skid	non-skid

Note: PlyPaks contain multiple pieces shrink wrapped for easy handling and protection from dirt and marks.



**Bending
PVC trim**

**How to clean,
finish & paint
PVC trim**



Trim Board measurements are nominal. All Sheet and 5/8" Trim Board measurements are actual. Please see our website for more detailed information.

BuildReady

Accessories

5/4

Corners

(1" thickness)

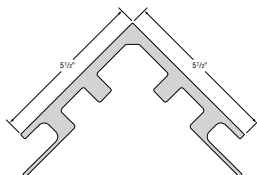
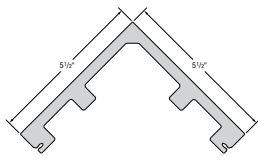
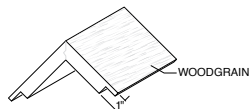
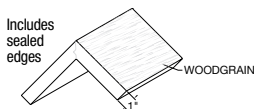
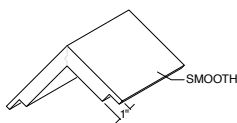
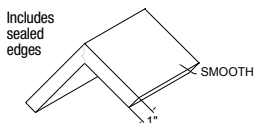

(This item has flexible nail fin not shown in illustration)

20' Offering	Smooth	Woodgrain	Selling UOM	Pieces/Selling Unit	Skid Length (Feet)	Skid Width (Feet)	Skid Height (Inches)
4 X 4	27845117-P	27848117-P	Unit	48	20	4	19.25
			Ply Pak	1	non-skid	non-skid	non-skid
4 x 4 w/J-Pocket	27845533-P	27848533-P	Unit	48	20	4	19.25
			Ply Pak	1	non-skid	non-skid	non-skid
6 X 6	27845118-P	27848118-P	Unit	32	20	4	27.25
			Ply Pak	1	non-skid	non-skid	non-skid
6 x 6 with J-Pocket	27845534-P	27848534-P	Unit	32	20	4	27.25
			Ply Pak	1	non-skid	non-skid	non-skid
6 x 6 Outside Corner w/nail fin	27845567-MB	n/a	Bundle	3	non-skid	non-skid	non-skid
6 x 6 Outside J-Pocket Corner w/nail fin	27845568-MB	n/a	Bundle	3	non-skid	non-skid	non-skid

Note: PlyPaks contain multiple pieces shrink wrapped for easy handling and protection from dirt and marks.

Trim Board measurements are nominal. All Sheet and 5/8" Trim Board measurements are actual. Please see our website for more detailed information.

BuildReady Accessories

5/4
Skirtboard
(1" thickness)

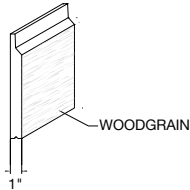
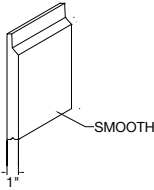

20' Offering	Smooth	Woodgrain	Selling UOM	Pieces/Selling Unit	Skid Length (Feet)	Skid Width (Feet)	Skid Height (Inches)
4" (face dimension 2-1/8")	27845535-P	27848535-P	Unit	96	18	4	13.25
			Ply Pak	2	non-skid	non-skid	non-skid
6" (face dimension 4-1/8")	27845536-P	27848536-P	Unit	36	18	4	13.25
			Ply Pak	2	non-skid	non-skid	non-skid
8" (face dimension 5-7/8")	27845537-P	27848537-P	Unit	30	18	4	10.25
			Ply Pak	2	non-skid	non-skid	non-skid

Specialty Offerings

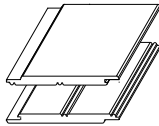

5" Beadboard

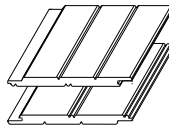

6" Beadboard

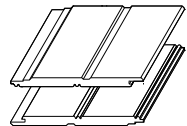

Moulded Beadboard

18' Offering	Smooth	Woodgrain	Selling UOM	Pieces/Selling Unit	Skid Length (Feet)	Skid Width (Feet)	Skid Height (Inches)
5" (installed coverage - 4.9")	27845600-P	n/a	Unit	96	18	4	13.25
			Ply Pak	6	non-skid	non-skid	non-skid
6" (installed coverage - 6")	27845063-P	n/a	Unit	96	18	4	13.25
			Ply Pak	4	non-skid	non-skid	non-skid
Moulded Beadboard (installed coverage - 5-1/2")	27845566-MB	n/a	Bundle	12	non-skid	non-skid	non-skid

Note: All Beadboard has smooth backing.

Trim Board measurements are nominal. All Sheet and 5/8" Trim Board measurements are actual. Please see our website for more detailed information.

BuildReady

Accessories

Cortex

Fasteners

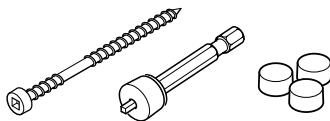

2" Length	Smooth	Woodgrain	Selling UOM	Pieces/Selling Unit	Skid Length (Feet)	Skid Width (Feet)	Skid Height (Inches)
50 linear feet / 75 screws	27845538-C	27848538-C	Carton	10	non-skid	non-skid	non-skid
250 linear feet / 375 screws	27845539-C	27848539-C	Carton	6	non-skid	non-skid	non-skid
750 linear feet / 1126 screws	27845540-C	27848540-C	Carton	1	non-skid	non-skid	non-skid
2" Length	Smooth	Woodgrain	Selling UOM	Pieces/Selling Unit	Skid Length (Feet)	Skid Width (Feet)	Skid Height (Inches)
250 linear feet / 375 screws	27845643-C	27848643-C	Carton	4	non-skid	non-skid	non-skid
2-3/4" Length	Smooth	Woodgrain	Selling UOM	Pieces/Selling Unit	Skid Length (Feet)	Skid Width (Feet)	Skid Height (Inches)
50 linear feet / 75 screws	27845612-C	27848612-C	Carton	-	non-skid	non-skid	non-skid
250 linear feet / 375 screws	27845613-C	27848613-C	Carton	-	non-skid	non-skid	non-skid
750 linear feet / 1126 screws	27845614-C	27848614-C	Carton	-	non-skid	non-skid	non-skid
2-3/4" Length	Smooth	Woodgrain	Selling UOM	Pieces/Selling Unit	Skid Length (Feet)	Skid Width (Feet)	Skid Height (Inches)
250 linear feet / 375 screws	27845644-C	27848644-C	Carton	-	non-skid	non-skid	non-skid
Plug only 40 PLG/Bag	27845645-C	27848645-C	Bag	400	non-skid	non-skid	non-skid

Note: PlyPaks contain multiple pieces shrink wrapped for easy handling and protection from dirt and marks.

Trim Board measurements are nominal. All Sheet and 5/8" Trim Board measurements are actual. Please see our website for more detailed information.

BuildReady Accessories

One-Piece Post Wraps & Accessories

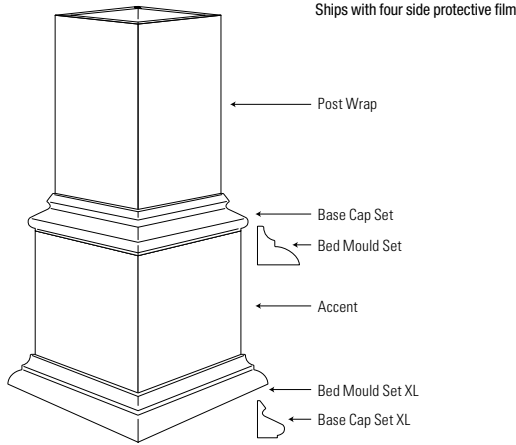

4 X 4 Nominal	Smooth	Selling UOM	Pieces/Selling Unit	Skid Length (Feet)	Skid Width (Feet)	Skid Height (Inches)
4 x 4 - 8'6" Length	27845541-C	Unit	48	9.0	3.75	25
		Carton	1	non-skid	non-skid	non-skid
4 x 4 - 10' Length	27845542-C	Unit	48	10.4	3.75	25
		Carton	1	non-skid	non-skid	non-skid
4 x 4 - Accent Wrap (12" length)	27845545-C	Carton	10	non-skid	non-skid	non-skid
4 x 4 - Bed Mould Set	27845543-C	Carton	20	non-skid	non-skid	non-skid
4 x 4 - Bed Mould Set XL	27845546-C	Carton	20	non-skid	non-skid	non-skid
4 x 4 - Base Cap Set	27845544-C	Carton	20	non-skid	non-skid	non-skid
4 x 4 - 4" Base Cap Set XL	27845547-C	Carton	20	non-skid	non-skid	non-skid
4X Belmont Post Cap	27845562-C	Carton	2	non-skid	non-skid	non-skid
4X Windsor Post Cap	27845563-C	Carton	1	non-skid	non-skid	non-skid
Basic Decor Kit (4 moulding sets & glue)	27845629-Kit	Kit	1	non-skid	non-skid	non-skid
Premium Decor Kit (5 moulding sets, 2 accents & glue)	27845630-Kit	Kit	1	non-skid	non-skid	non-skid

Trim Board measurements are nominal. All Sheet and 5/8" Trim Board measurements are actual. Please see our website for more detailed information.

BuildReady

Accessories

One-Piece Post Wraps

& Accessories

6 X 6 Nominal	Smooth	Selling UOM	Pieces/ Selling Unit	Skid Length (Feet)	Skid Width (Feet)	Skid Height (Inches)
6 x 6 - 8'6" Length	27845548-C	Unit	48	9.0	3.75	25
		Carton	1	non-skid	non-skid	non-skid
6 x 6 - 10' Length	27845549-C	Unit	48	10.4	3.75	25
		Carton	1	non-skid	non-skid	non-skid
6 x 6 - Accent Wrap (12" length)	27845552-C	Carton	10	non-skid	non-skid	non-skid
6 x 6 - Bed Mould Set	27845550-C	Carton	20	non-skid	non-skid	non-skid
6 x 6 - Bed Mould Set XL	27845553-C	Carton	20	non-skid	non-skid	non-skid
6 x 6 - Base Cap Set	27845551-C	Carton	20	non-skid	non-skid	non-skid
6 x 6 - Base Cap Set XL	27845554-C	Carton	20	non-skid	non-skid	non-skid
6X Belmont Post Cap	27845564-C	Carton	2	non-skid	non-skid	non-skid
6X Windsor Post Cap	27845565-C	Carton	1	non-skid	non-skid	non-skid
Basic Decor Kit (4 moulding sets & glue)	27845631-Kit	Kit	1	non-skid	non-skid	non-skid
Premium Decor Kit (5 moulding sets, 2 accents & glue)	27845632-Kit	Kit	1	non-skid	non-skid	non-skid
8 X 8 Nominal	Smooth	Selling UOM	Pieces/ Selling Unit	Skid Length (Feet)	Skid Width (Feet)	Skid Height (Inches)
8 x 8 - 8' 6" Length	27845555-C	Unit	36	9.0	3.75	28
		Carton	1	non-skid	non-skid	non-skid
8 x 8 - 10'	27845556-C	Unit	36	10.4	3.75	28
		Carton	1	non-skid	non-skid	non-skid
8 x 8 Accent Wrap (12" length)	27845559-C	Carton	10	non-skid	non-skid	non-skid
Bed Mould Set	27845557-C	Carton	20	non-skid	non-skid	non-skid
Bed Mould Set XL	27845560-C	Carton	20	non-skid	non-skid	non-skid
Base Cap Mould Set	27845558-C	Carton	20	non-skid	non-skid	non-skid
Base Cap Set XL	27845561-C	Carton	20	non-skid	non-skid	non-skid
Glue with Tip	27845606-C	Carton	12	non-skid	non-skid	non-skid
Basic Decor Kit (4 moulding sets & glue)	27845633-Kit	Kit	1	non-skid	non-skid	non-skid
Premium Decor Kit (5 moulding sets, 2 accents & glue)	27845634-Kit	Kit	1	non-skid	non-skid	non-skid
10 X 10 Nominal	Smooth	Selling UOM	Pieces/ Selling Unit	Skid Length (Feet)	Skid Width (Feet)	Skid Height (Inches)
10 x 10 - 8'6" Length	27845648-C	Unit	36	9	3.75	28
		Carton	1	non-skid	non-skid	non-skid
10 x 10 - 10' Length	27845668-C	Unit	36	10.4	3.75	28
		Carton	1	non-skid	non-skid	non-skid
10 x 10 - Accent Wrap (12" length)	27845652-C	Carton	10	non-skid	non-skid	non-skid
10 x 10 - Bed Mould Set	27845650-C	Carton	20	non-skid	non-skid	non-skid
10 x 10 - Bed Mould Set XL	27845653-C	Carton	20	non-skid	non-skid	non-skid
10 x 10 - Base Cap Set	27845651-C	Carton	20	non-skid	non-skid	non-skid
10 x 10 - Base Cap Set XL	27845654-C	Carton	20	non-skid	non-skid	non-skid

Note: Bed and Base Cap sets are pre-mitered and dove-tailed for easy installation. "XL" indicates size to fit accents. Included in the basic kit: • 2 BedMolds • 2 Base Caps • Glue with tip. Included in the premium kit: • 2 Accent Wraps • 2 XL Bed Molds • 3 Base Caps • Glue with tip.

Trim Board measurements are nominal. All Sheet and 5/8" Trim Board measurements are actual. Please see our website for more detailed information.

BuildReady

Mouldings

Brick Mould

Item Number	Length	Selling UOM	Pieces/ Selling Unit	Skid Length (Feet)	Skid Width (Feet)	Skid Height (Inches)
27845573-MB	17'6"	Unit	252	18'	3.9	20.5
		Bundle	6	non-skid	non-skid	non-skid

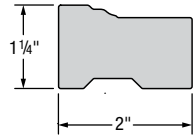

J Brick

Item Number	Length	Selling UOM	Pieces/ Selling Unit	Skid Length (Feet)	Skid Width (Feet)	Skid Height (Inches)
27845574-MB	18'	Unit	240	18"	3.9	20.5
		Bundle	8	non-skid	non-skid	non-skid

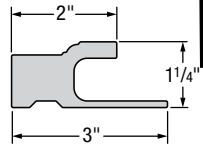

Brick Mould w/ nail fin for hard board nailing

Item Number	Length	Selling UOM	Pieces/ Selling Unit	Skid Length (Feet)	Skid Width (Feet)	Skid Height (Inches)
27845575-MB	18'	Unit	240	18"	3.9	20.5
		Bundle	6	non-skid	non-skid	non-skid

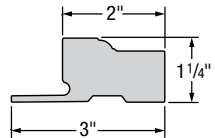

Base Cap

Item Number	Length	Selling UOM	Pieces/ Selling Unit	Skid Length (Feet)	Skid Width (Feet)	Skid Height (Inches)
27845571-MB	16'	Unit	936	18"	3.9	20.5
		Bundle	36	non-skid	non-skid	non-skid

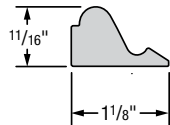

Bed Mould

Item Number	Length	Selling UOM	Pieces/ Selling Unit	Skid Length (Feet)	Skid Width (Feet)	Skid Height (Inches)
27845572-MB	16'	Unit	750	18"	3.9	20.5
		Bundle	25	non-skid	non-skid	non-skid

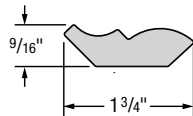

Trim Board measurements are nominal. All Sheet and 5/8" Trim Board measurements are actual. Please see our website for more detailed information.

BuildReady

Mouldings

Drip Cap

Item Number	Length	Selling UOM	Pieces/Selling Unit	Skid Length (Feet)	Skid Width (Feet)	Skid Height (Inches)
27845580-MB	16'	Unit	660	20"	3.9	20.5
		Bundle	20	non-skid	non-skid	non-skid

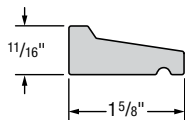

Rake Mould

Item Number	Length	Selling UOM	Pieces/Selling Unit	Skid Length (Feet)	Skid Width (Feet)	Skid Height (Inches)
27845582-MB	16'	Unit	270	18"	3.9	20.5
		Bundle	10	non-skid	non-skid	non-skid

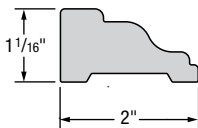

Panel Moulding

Item Number	Length	Selling UOM	Pieces/Selling Unit	Skid Length (Feet)	Skid Width (Feet)	Skid Height (Inches)
27845595-MB	16'	Unit	672	18"	3.9	20.5
		Bundle	24	non-skid	non-skid	non-skid

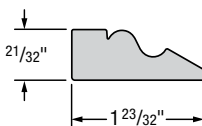

Shingle Mould

Item Number	Length	Selling UOM	Pieces/Selling Unit	Skid Length (Feet)	Skid Width (Feet)	Skid Height (Inches)
27845585-MB	16'	Unit	480	18"	3.9	20.5
		Bundle	20	non-skid	non-skid	non-skid

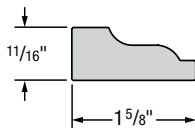

Quarter Round

Item Number	Length	Selling UOM	Pieces/Selling Unit	Skid Length (Feet)	Skid Width (Feet)	Skid Height (Inches)
27845581-MB	16'	Unit	600	18"	3.9	20.5
		Bundle	25	non-skid	non-skid	non-skid

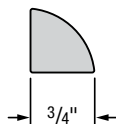

Trim Board measurements are nominal. All Sheet and 5/8" Trim Board measurements are actual. Please see our website for more detailed information.

BuildReady

Mouldings

Scotia Cove

Item Number	Length	Selling UOM	Pieces/ Selling Unit	Skid Length (Feet)	Skid Width (Feet)	Skid Height (Inches)
27845583-MB	16'	Unit	600	18"	3.9	20.5
		Bundle	25	non-skid	non-skid	non-skid

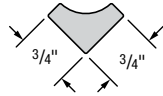

3X Crown

Item Number	Length	Selling UOM	Pieces/ Selling Unit	Skid Length (Feet)	Skid Width (Feet)	Skid Height (Inches)
27845586-MB	16'	Unit	420	18"	3.9	20.5
		Bundle	10	non-skid	non-skid	non-skid

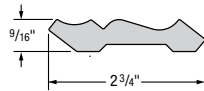

4X Crown

Item Number	Length	Selling UOM	Pieces/ Selling Unit	Skid Length (Feet)	Skid Width (Feet)	Skid Height (Inches)
27845576-MB	16'	Unit	330	18"	3.9	20.5
		Bundle	10	non-skid	non-skid	non-skid

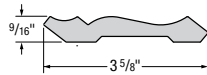

5X Crown

Item Number	Length	Selling UOM	Pieces/ Selling Unit	Skid Length (Feet)	Skid Width (Feet)	Skid Height (Inches)
27845577-MB	16'	Unit	128	18"	3.9	20.5
		Bundle	4	non-skid	non-skid	non-skid

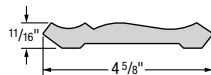

6X Crown

Item Number	Length	Selling UOM	Pieces/ Selling Unit	Skid Length (Feet)	Skid Width (Feet)	Skid Height (Inches)
27845578-MB	16'	Unit	168	18"	3.9	20.5
		Bundle	6	non-skid	non-skid	non-skid

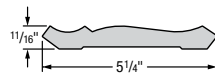

Trim Board measurements are nominal. All Sheet and 5/8" Trim Board measurements are actual. Please see our website for more detailed information.

BuildReady

Mouldings

8X Crown

Item Number	Length	Selling UOM	Pieces/Selling Unit	Skid Length (Feet)	Skid Width (Feet)	Skid Height (Inches)
27845601-MB	16'	Unit	98	18"	3.9	20.5
		Bundle	2	non-skid	non-skid	non-skid

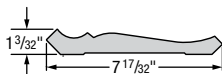

Rams Crown

Item Number	Length	Selling UOM	Pieces/Selling Unit	Skid Length (Feet)	Skid Width (Feet)	Skid Height (Inches)
27845579-MB	16'	Unit	180	18"	3.9	20.5
		Bundle	6	non-skid	non-skid	non-skid

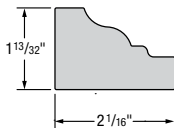

Imperial Rake Crown

Item Number	Length	Selling UOM	Pieces/Selling Unit	Skid Length (Feet)	Skid Width (Feet)	Skid Height (Inches)
27845596-MB	16'	Unit	240	18"	3.9	20.5
		Bundle	8	non-skid	non-skid	non-skid

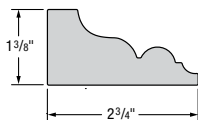

Solid Crown

Item Number	Length	Selling UOM	Pieces/Selling Unit	Skid Length (Feet)	Skid Width (Feet)	Skid Height (Inches)
27845597-MB	16'	Unit	280	18"	3.9	20.5
		Bundle	8	non-skid	non-skid	non-skid

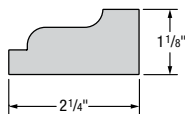

Pediment

Item Number	Length	Selling UOM	Pieces/Selling Unit	Skid Length (Feet)	Skid Width (Feet)	Skid Height (Inches)
27845598-MB	12'	Unit	168	18"	3.9	20.5
		Bundle	4	non-skid	non-skid	non-skid

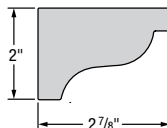

Trim Board measurements are nominal. All Sheet and 5/8" Trim Board measurements are actual. Please see our website for more detailed information.

BuildReady

Mouldings

Back Band

Item Number	Length	Selling UOM	Pieces/ Selling Unit	Skid Length (Feet)	Skid Width (Feet)	Skid Height (Inches)
27845590-MB	16'	Unit	280	18"	3.9	20.5
		Bundle	10	non-skid	non-skid	non-skid

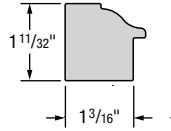

Adams Casing

Item Number	Length	Selling UOM	Pieces/ Selling Unit	Skid Length (Feet)	Skid Width (Feet)	Skid Height (Inches)
27845594-MB	16'	Unit	180	18"	3.9	20.5
		Bundle	6	non-skid	non-skid	non-skid

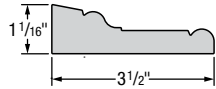

Water Table

Item Number	Length	Selling UOM	Pieces/ Selling Unit	Skid Length (Feet)	Skid Width (Feet)	Skid Height (Inches)
27845599-MB	18'	Unit	216	18"	3.9	20.5
		Bundle	4	non-skid	non-skid	non-skid

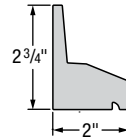

1-1/2" Square

Item Number	Length	Selling UOM	Pieces/ Selling Unit	Skid Length (Feet)	Skid Width (Feet)	Skid Height (Inches)
27845587-MB	16'	Unit	304	18"	3.9	20.5
		Bundle	4	non-skid	non-skid	non-skid

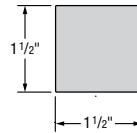

Sub Sill Nose

Item Number	Length	Selling UOM	Pieces/ Selling Unit	Skid Length (Feet)	Skid Width (Feet)	Skid Height (Inches)
27845591-MB	16'	Unit	360	18"	3.9	20.5
		Bundle	12	non-skid	non-skid	non-skid

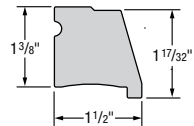

Trim Board measurements are nominal. All Sheet and 5/8" Trim Board measurements are actual. Please see our website for more detailed information.

BuildReady

Mouldings

Historic Sill

Item Number	Length	Selling UOM	Pieces/Selling Unit	Skid Length (Feet)	Skid Width (Feet)	Skid Height (Inches)
27845584-MB	16'	Unit	144	18"	3.9	20.5
		Bundle	4	non-skid	non-skid	non-skid

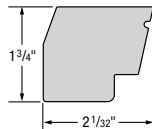

Window Sill Nose

Item Number	Length	Selling UOM	Pieces/Selling Unit	Skid Length (Feet)	Skid Width (Feet)	Skid Height (Inches)
27845592-MB	12'	Unit	270	18"	3.9	20.5
		Bundle	9	non-skid	non-skid	non-skid

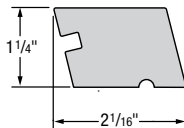

Large Sill Nose

Item Number	Length	Selling UOM	Pieces/Selling Unit	Skid Length (Feet)	Skid Width (Feet)	Skid Height (Inches)
27845593-MB	16'	Unit	180	18"	3.9	20.5
		Bundle	4	non-skid	non-skid	non-skid

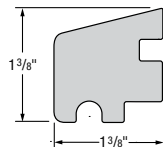

Window Sill

Item Number	Length	Selling UOM	Pieces/Selling Unit	Skid Length (Feet)	Skid Width (Feet)	Skid Height (Inches)
27845602-MB	12'	Unit	84	18"	3.9	20.5
		Bundle	4	non-skid	non-skid	non-skid

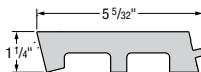

Trim Board measurements are nominal. All Sheet and 5/8" Trim Board measurements are actual. Please see our website for more detailed information.

DesignReady Trim

5/8

Trim Board

(5/8" actual)

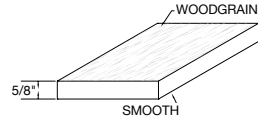
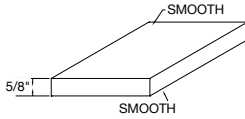

18' Lengths	Smooth	Woodgrain	Selling UOM	Pieces/Selling Unit	Skid Length (Feet)	Skid Width (Feet)	Skid Height (Inches)
5/8" x 4	27885001	27887001	Unit	130	18	4	11.5
5/8" x 6	27885002	27887002	Unit	80	18	4	11.5
5/8" x 8	27885003	27887003	Unit	60	18	4	11.5
5/8" x 10	27885004	27887004	Unit	50	18	4	11.5
5/8" x 12	27885005	27887005	Unit	40	18	4	11.5
5/8" x 16	27885078	27887078	Unit	30	18	4	11.5

4/4

Trim Board

(3/4" actual)

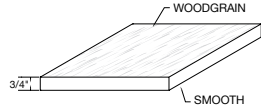
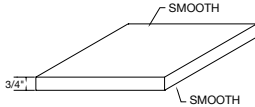

12' Offering	Smooth	Woodgrain	Selling UOM	Pieces/Selling Unit	Skid Length (Feet)	Skid Width (Feet)	Skid Height (Inches)
1 x 4	27885146	27887146	Unit	104	12	4	11.1
1 x 6	27885147	27887147	Unit	64	12	4	11.1
1 x 8	27885148	27887148	Unit	48	12	4	11.1
1 x 10	27885149	27887149	Unit	40	12	4	11.1
1 x 12	27885150	27887150	Unit	32	12	4	11.1

18' Offering	Smooth	Woodgrain	Selling UOM	Pieces/Selling Unit	Skid Length (Feet)	Skid Width (Feet)	Skid Height (Inches)
1 x 4	27885006	27887006	Unit	104	18	4	11.1
1 x 6	27885009	27887009	Unit	64	18	4	11.1
1 x 8	27885010	27887010	Unit	48	18	4	11.1
1 x 10	27885011	27887011	Unit	40	18	4	11.1
1 x 12	27885012	27887012	Unit	32	18	4	11.1
1 x 16	27885377	27887377	Unit	24	18	4	11.1

20' Offering	Smooth	Woodgrain	Selling UOM	Pieces/Selling Unit	Skid Length (Feet)	Skid Width (Feet)	Skid Height (Inches)
1 x 3	27885519	27887519	Unit	114	20	4	9.6
1 x 4	27885513	27887513	Unit	104	20	4	11.1
1 x 6	27885514	27887514	Unit	64	20	4	11.1
1 x 8	27885515	27887515	Unit	48	20	4	11.1
1 x 10	27885516	27887516	Unit	40	20	4	11.1
1 x 12	27885517	27887517	Unit	32	20	4	11.1
1 x 16	27885518	27887518	Unit	24	20	4	11.1

Trim Board measurements are nominal. All Sheet and 5/8" Trim Board measurements are actual. Please see our website for more detailed information.

DesignReady

Trim

5/4

Trim Board

(1" actual)

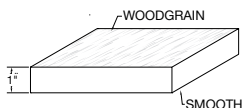
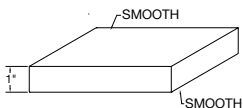

12' Offering	Smooth	Woodgrain	Selling UOM	Pieces/ Selling Unit	Skid Length (Feet)	Skid Width (Feet)	Skid Height (Inches)
5/4 x 4	27885156	27887156	Unit	78	12	4	11
5/4 x 6	27885157	27887157	Unit	48	12	4	11
5/4 x 8	27885158	27887158	Unit	36	12	4	11
5/4 x 10	27885187	27887187	Unit	30	12	4	11
5/4 x 12	27885208	27887208	Unit	24	12	4	11

18' Offering	Smooth	Woodgrain	Selling UOM	Pieces/ Selling Unit	Skid Length (Feet)	Skid Width (Feet)	Skid Height (Inches)
5/4 x 4	27885013	27887013	Unit	78	18	4	11
5/4 x 5	27885015	27887015	Unit	48	18	4	11
5/4 x 6	27885016	27887016	Unit	36	18	4	11
5/4 x 8	27885017	27887017	Unit	30	18	4	11
5/4 x 10	27885018	27887018	Unit	24	18	4	11
5/4 x 12	27885527	27887527	Unit	18	18	4	11
5/4 x 16	27845527	27848527	Unit	18	18	4	11

20' Offering	Smooth	Woodgrain	Selling UOM	Pieces/ Selling Unit	Skid Length (Feet)	Skid Width (Feet)	Skid Height (Inches)
5/4 x 4	27885072	27887072	Unit	78	20	4	11
5/4 x 6	27885074	27887074	Unit	48	20	4	11
5/4 x 8	27885075	27887075	Unit	36	20	4	11
5/4 x 10	27885076	27887076	Unit	30	20	4	11
5/4 x 12	27885077	27887077	Unit	24	20	4	11
5/4 x 16	27885405	27887405	Unit	18	20	4	11

5/4

Trim Board

(1" actual)

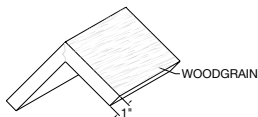

20' Offering	Woodgrain	Selling UOM	Pieces/ Selling Unit	Skid Length (Feet)	Skid Width (Feet)	Skid Height (Inches)
4 x 4	27887117-P	Units	48	20	4	19.25
		PlyPak	1	20	4	
6 x 6	27887118-P	Unit	32	20	4	27.25
		PlyPak	1	20	4	

Note: PlyPaks contain multiple pieces shrink wrapped for easy handling and protection from dirt and marks. Corners do not have film or sealed edges.

Trim Board measurements are nominal. All Sheet and 5/8" Trim Board measurements are actual. Please see our website for more detailed information.

DesignReady Trim

Sheet

(All measurements
actual)

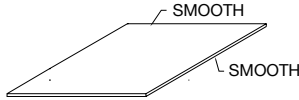

4' Wide & 8' Lengths	Smooth	Selling UOM	Pieces/Selling Unit	Skid Length (Feet)	Skid Width (Feet)	Skid Height (Inches)
3/8" Sheet	27885080	Unit	30	8	4	16.5
1/2" Sheet	27885037	Unit	25	8	4	17.8
5/8" Sheet	27885039	Unit	25	8	4	20.9
3/4" Sheet	27885042	Unit	20	8	4	20.3
1" Sheet	27885046	Unit	20	8	4	25.3

4' Wide & 10' Lengths	Smooth	Selling UOM	Pieces/Selling Unit	Skid Length (Feet)	Skid Width (Feet)	Skid Height (Inches)
3/8" Sheet	27885081	Unit	30	10	4	16.5
1/2" Sheet	27885038	Unit	25	10	4	17.8
5/8" Sheet	27885040	Unit	25	10	4	20.9
3/4" Sheet	27885043	Unit	20	10	4	20.3
1" Sheet	27885047	Unit	20	10	4	25.3

4' Wide & 12' Lengths	Smooth	Selling UOM	Pieces/Selling Unit	Skid Length (Feet)	Skid Width (Feet)	Skid Height (Inches)
3/8" Sheet	27885165	Unit	30	12	4	16.5
1/2" Sheet	27885229	Unit	25	12	4	17.8
5/8" Sheet	27885159	Unit	25	12	4	20.9
3/4" Sheet	27885044	Unit	20	12	4	20.3
1" Sheet	27885048	Unit	20	12	4	25.3

4' Wide & 18' Lengths	Smooth	Selling UOM	Pieces/Selling Unit	Skid Length (Feet)	Skid Width (Feet)	Skid Height (Inches)
3/8" Sheet	27885138	Unit	30	18	4	16.5
1/2" Sheet	27885400	Unit	25	18	4	17.8
5/8" Sheet	27885041	Unit	20	18	4	17.8
3/4" Sheet	27885045	Unit	18	18	4	18.8
1" Sheet	27885401	Unit	12	18	4	17.3

Trim Board measurements are nominal. All Sheet and 5/8" Trim Board measurements are actual. Please see our website for more detailed information.

Specifications and Conformance

TECHNICAL SPECIFICATIONS

Panels tested in accordance with ASTM D5206. Windspeed rating will vary depending on specific code region and construction method. Refer to local building codes for detailed requirements concerning allowable wind loads and specified conversion tables for actual windspeed.

Mastic Product Line	2024 IBC/IRC	
	Design Pressure Rating	Maximum Windspeed (mph)
		ASD
Cedar Discovery Hand-Split Shake	114	218
Cedar Discovery Perfection Shingle	105	209
Structure Home Insulation System	69	169
Cedar Discovery Half-Round	68	168
7" Board & Batten Vinyl Siding	67	167
Quest	64	163
Carvedwood 44	56	153
Western Extreme	56	153
Charleston Beaded	51	146
Ovation 6 -1/2 Beaded Woodgrain	51	146
Pro-Bead	42	132
Pro-Select	42	132
Pro-Tech Plus	42	132
Ventura Triple 3- 1/3" Non-Vent/ Soffit/Wainscot	42	132
Eclipse	40	129
Mill Creek	40	129
Ovation	40	129
Ovation SolarDefense Reflective Technology	40	129

Example wind velocity for 40 PSF is 129 MPH Zone B @ 30' building height

VINYL SIDING + SOFFIT

Mastic siding and soffit products are designed for use in residential and light commercial applications.

FINISH

Mastic vinyl siding and soffit are produced from a PVC compound containing quality color pigments to provide color throughout the thickness of the panel. Close control of color and gloss is maintained to provide for an attractive, weatherable surface. Textured vinyl panels are uniformly embossed to provide an attractive woodgrain pattern.

For cedar-look colors, Kynar 500[®] has been formulated into a film, which becomes an integral part of an exclusive layering process. The film finish system exhibits no cracking, blistering, corrosion or loss of adhesion when subjected to extreme test cycles of cold, heat, acid rain and humidity. Test results are available upon request.

*Kynar 500[®] is a registered trademark of Elf Atochem North America, Inc.

MANUFACTURING PHYSICALS

Solid vinyl siding, soffit and accessories are an extruded polyvinyl chloride (PVC) compound as defined in ASTM D3679, Standard Specification for PVC Siding.[™]

Mastic PVC resin meets or exceeds the properties listed here:

Tensile strength (psi)	7,100 – 7,600
Tensile modulus (psi)	360,000 – 400,000
Specific gravity	1.39 – 1.49
Hardness (ShoreD)	76 ± 3
Heat deflection under load 264 psi	170°F
Izod impact strength (ft-lbs/in of notch)	3.3
Chemical resistance	Excellent
Coefficient of linear expansion	2.9 (73.7) X 10 ⁻⁵

THICKNESS

Mastic vinyl siding and soffit panels exceed requirements per ASTM D3679 section 4.2.

Siding thickness (nominal)

Board+Batten Designer Series®	.048" (1.22)	Ovation™	.042" (1.07)
Passage™	.050" (1.27)	Mill Creek®	.040" (1.02)
Structure® (Vinyl)	.046" (1.17)	Eclipse™	.040" (1.02)
Charleston Beaded™	6-1/2"	Quest®	.046" (1.17)
(Contemporary)	.048" (1.12)	Carvedwood•44™	.044" (1.16)

Soffit thickness (nominal)

Ventura®	.044" (1.12)	Pro-Tech® Plus Double 5"	.042" (1.07)
Pro-Bead®	.040" (1.02)	Universal D5	.040" (1.02)
Pro-Select®	.046" (1.17)	Universal T4	.036" (0.91)
Pro-Tech® Plus Triple 4"	.040" (1.02)		

NOTE: All measurements noted in () are in centimeters (cm).

VENTILATION AREA

(Free air space area in sq in/sq ft)

Ventura®	9.19 sq in (59.290 cm ²)	Pro-Tech® Plus Double 5"	7.53 sq in (48.581 cm ²)
Pro-Bead®	1.54 sq in (9.9355 cm ²)	Pro-Tech® Plus Triple 4"	5.87 sq in (37.871 cm ²)
Pro-Select®	7.53 sq in (48.581 cm ²)	Universal D5	7.53 sq in (48.581 cm ²)
Pro-Tech® Plus Triple 4"	5.87 sq in (37.871 cm ²)	Universal T4	5.87 sq in (37.871 cm ²)

RELEVANT STANDARDS/CODES

Mastic vinyl siding products meet or exceed the following industry standards and/or building code approvals:

Standards and Codes

ASTM	Patent #
ASTM	C1363
ASTM	C272
ASTM	D2843
ASTM	D635
ASTM	E84
ASTM	E96
ASTM	D3679
ASTM	D4477
ASTM	D7793
Metro Dade	22-1108.04
State of Florida - Aluminum, Plastic and Vinyl Siding	FL32869
State of Florida - Aluminum and Vinyl Soffit	FL32502
Texas State Board of Insurance Ruling	EC-27
ICC Evaluation Service	ESR-1565

Fire-Resistance Ratings

ASTM E84		ASTM D635	
Flame spread	less than 20	Avg. time of burning	less than 5 sec.
Fuel contribution	0	Avg. length of burning	20 mm
Smoke density	400		
		ASTM D2843	
ASTM E-119		Smoke density	48
1 hour firewall,			
1 hour firewall,			
Standard test		Intermediate-scale	
method for fire		Multistory fire test	
Tests of building			
Construction and materials			

IMPORTANT: FIRE SAFETY INFORMATION

Exterior vinyl building materials require little maintenance for many years. Nevertheless, common sense dictates that builders and suppliers of vinyl products store, handle and install vinyl materials in a manner that avoids damage to the product and/or structure. Owners and installers should take a few simple steps to protect vinyl building materials from fire.

To Home and Building Owners

Rigid vinyl siding is made from organic materials and will melt or burn when exposed to a significant source of flame or heat. Building owners, occupants and outside maintenance personnel should always take normal precautions to keep sources of fire, such as barbecues, and combustible materials, dry leaves, mulch and trash away from vinyl siding.

To Building Trades, Specifiers, Professionals and Do-it-Yourself Installers

When rigid vinyl siding is exposed to significant heat or flames, the vinyl will soften, sag, melt or burn, and may thereby expose material underneath. Care must be exercised when selecting underlayment materials because many underlayment materials are made from organic materials that are combustible. Fire properties of underlayment materials should be ascertained prior to installation. All building materials should be installed in accordance with local, state and federal building code and fire regulations.

WALL FIRE RESISTANCE MATRIX				
	Wall System	Interior Underlayment	Exterior Sheathing	Popular Residential Claddings*
Non-rated Wall	Any conventional construction	1/2" gypsum board	Any conventional materials	Wood Plywood OSB Hardboard Steel Aluminum Vinyl
One-hour Rating	Any conventional construction	1 layer of 5/8" gypsum board	MUST INCLUDE 1 layer of 5/8" gypsum board	
Two-hour Rating	Any conventional construction	2 layers of 5/8" gypsum board	MUST INCLUDE 2 layers of 5/8" gypsum board	

*NOTE: Fire-treated versions may also be available for some popular wood-based siding products. For general information about vinyl siding products, contact the Vinyl Siding Institute, 1800 Diagonal Rd. Suite 545 Alexandria, VA 22314. Request brochures titled, "Fire Properties" and "What Homeowners Want to Know."

WARRANTY

Mastic backs its vinyl siding and soffit with a Mastic V.I.P. Limited Lifetime Warranty. Many products also include hail coverage. Consult actual warranty certificates for complete coverage details.

CEDAR DISCOVERY® SHINGLE SIDING

Mastic Cedar Discovery® shingle siding is designed for use in residential and light commercial applications.

FINISH

Cedar Discovery® shingle siding is produced from a polypropylene compound containing quality color pigments to provide color throughout the thickness of the panel. Close control of color and gloss is maintained to provide for an attractive, weatherable surface.

MANUFACTURING PHYSICALS

Double 7" Perfection Shingle Siding

1. Style: Double 7" profile, 14" exposure
2. Butt dimension: 3/4"
3. Length: 67-1/2"
4. Nail hem: continuous locking nail hem
5. Thickness: nominal .080"
6. Material: polypropylene

Half-Round

1. Style: Double Round 6-1/4" profile, 12-1/2" exposure
2. Butt dimension: 3/4"
3. Length: 51-3/4"
4. Nail hem: continuous locking nail hem
5. Thickness: nominal .080"
6. Material: polypropylene

Triple 5" Perfection Shingle Siding

1. Style: Triple 5" profile, 15" exposure
2. Butt dimension: 3/4"
3. Length: 69-1/2"
4. Nail hem: continuous locking nail hem
5. Thickness: nominal .100"
6. Material: polypropylene

Hand-Split Shake

1. Style: Double 9-3/8" profile, 18-3/4" exposure
2. Butt dimension: 7/8"
3. Length: 67-3/4"
4. Nail hem: continuous locking nail hem
5. Thickness: nominal .080"
6. Material: polypropylene

RELEVANT STANDARDS/CODES

Cedar Discovery® shingle siding is a rigid polypropylene siding. Cedar Discovery® shingle siding, tested in compliance to ASTM flame test procedures, meets or exceeds the following properties as required by the national code bodies.

Burn rate	ASTM D635 – 1.15"/minute
Minimum self-ignition temperature	ASTM D1929 – 673F
Minimum flash-ignition temperature	ASTM D1929 – 651F
Flame spread and smoke developed	ASTM E84 – Flame 150, Smoke 710
Windload	ASTM D5206 – 80 psf, 180 mph

NOTE: Cedar Discovery® has been tested per ASTM D5206 standard test method for windload resistance of rigid PVC siding. Check with your local building inspector for windload requirements in your area.

DELIVERY, STORAGE AND HANDLING

Deliver rigid polypropylene siding products to the project site in their original packaging. Store rigid polypropylene products in their original packaging on a flat surface under cover, stacked no more than 12 boxes high. Do not store in a location where temperatures may exceed 130F.

IMPORTANT: FIRE SAFETY INFORMATION

Rigid polypropylene siding is made from organic materials and will melt or burn when exposed to a significant source of flame or heat. Property owners, occupants and maintenance personnel should be familiar with the performance characteristics of underlayment materials. For maximum safety, non-combustible underlayment materials are recommended. Normal precautions to protect rigid polypropylene building materials from sources of fire should be taken. Barbecues and combustible materials, such as dry leaves, mulch and trash, should be kept away from polypropylene siding.

WARRANTY

Mastic Cedar Discovery® shingle siding has Mastic's V.I.P. Limited Lifetime Warranty. Consult the actual product warranty for complete coverage details.

ALUMINUM SIDING, SOFFIT + TRIM SHEET

Mastic siding and soffit products are designed for use in residential and light commercial applications.

FINISH

Siding and Soffit: The Alumalure® 2000 finish is a two-coat acrylic applied in a two-phase operation that includes a corrosion-inhibiting primer and a baked-on, high-performance acrylic topcoat.

TABLE OF CONTENTS

Trim Sheet: Available in the Alumalure® 2000 smooth finish and the PVC coated striated finish. All Mastic aluminum siding and soffit panels exceed requirements per AAMA 1402.86.

MANUFACTURING PHYSICALS

Mastic aluminum siding and soffit are made of 3105 aluminum sheet (minimum tensile strength 29,000 psi; minimum yield strength 26,000 psi).

THICKNESS

Siding thickness (nominal)

Endurance® Rustic Double 4"	.019 (.483)	Envoy® Traditional Select 8"	.024 (.610)
Envoy® Rustic Double 4"	.024 (.610)	Envoy® Horizon Collection Double 5"	.024 (.610)
Endurance™ Double 5" Dutch Lap	.019 (.483)		

Soffit thickness (nominal)

Envoy®	.019 (.483)	Economy™	.013 (.331)
Endurance®	.016 (.406)		

Trim sheet thickness: Available in nominal .018, .019 and .024 thickness.

NOTE: All measurements noted in () are in millimeters (mm).

R-VALUE

Mastic aluminum siding, when installed over a flat wall, has an R-value of approximately 0.74. If applied over foil, the R-value increases to approximately 1.10.

SOFFIT VENTILATION AREA

(free air space area in sq cm/ft)

Envoy® 12", Double 6	15.0 sq in (96.774 cm ²)	perforated	(v-groove)
Envoy® 12", Double 6	7.94 sq in (51.226 cm ²)	full lanced	(v-groove)
Envoy® 6", Single	7.5 sq in (48.387 cm ²)	perforated	(v-groove)
Envoy® 12", Double 6	10.6 sq in (68.387 cm ²)	full lanced	(u-groove)
Envoy® 12", Triple 4	4.4 sq in (28.387 cm ²)	center lanced	(u-groove)
Envoy® 12", Triple 4	13.2 sq in (85.161 cm ²)	full lanced	(u-groove)
Envoy® 16", Quad 4	8.9 sq in (57.419 cm ²)	center lanced	(u-groove)
Endurance® 12", Double 6	15.0 sq in (96.774 cm ²)	perforated	(v-groove)
Endurance® 12", Double 6	10.6 sq in (68.387 cm ²)	full lanced	(u-groove)
Endurance® 12", Triple 4	4.4 sq in (28.387 cm ²)	center lanced	(u-groove)
Endurance® 12", Triple 4	13.2 sq in (85.161 cm ²)	full lanced	(u-groove)
Economy 12", Triple 4	4.4 sq in (28.387 cm ²)	center lanced	(u-groove)
Economy 12", Triple 4	13.2 sq in (85.161 cm ²)	full lanced	(u-groove)

RELEVANT STANDARDS/CODES

Mastic aluminum siding products meet or exceed the following standards and/or code approvals:

Industry Standards	Building Codes
AAMA	1402.86
FHA	4900.1 for single-family dwellings
FHA	4910.1 for two-family dwellings
DOD	4720.21 for military family housing
ICC Evaluation Service	ER-1478
Metro Dade	07-1026.01
State of Florida	5538
State of Florida	11191
State of Florida	5544-R1
State of Florida	5548
Texas State Board of Insurance Ruling	EC-27

PROTECTION

Direct contact of aluminum products with certain dissimilar materials, or contact with water run-off from dissimilar materials, is likely to result in corrosion. See warranty and installation instructions for more details.

WARRANTY

Mastic backs its aluminum siding, aluminum soffit and select aluminum trim coil with a Mastic V.I.P. Limited Lifetime Warranty. Consult warranty certificates for complete coverage details.

RAIN REMOVAL SYSTEMS

Mastic rain removal systems are designed for use in residential and light commercial applications.

MANUFACTURING PHYSICALS

All Mastic rain removal systems are made of 3105 aluminum sheet (minimum tensile strength 26,000 psi; minimum yield strength 22,000 psi) or equivalent. Mastic Rain Removal Systems are designed to be free-floating, enabling the gutters to expand and contract with temperature changes while minimizing stress points that cause buckling and leaks.

Mastic gutters, when properly installed, will support a minimum of 50 pounds (22.7 kg) per linear foot. Six different types of free-floating hanger systems are available in the 5" (127) series, and four hanger systems are available in the 6" (152.4) series. These hanger systems permit the gutter to be used in both new construction and all types of remodeling work. Gutter hangers are nominal .051" – .082" (1.3 – 2.1) thickness, depending on the style specified.

TABLE OF CONTENTS

All hanger systems provide a concealed attachment at the front of the gutter, eliminating any exposed protrusions that would detract from the appearance of the gutter. Spikes and ferrules (which restrict the movement of the gutter) and brackets attached to the outside periphery of the gutter not recommended.

Two different types of high-quality, corrosion-resistant Rain Removal Systems are available.

SYSTEM DESCRIPTION

Envoy® 5" is a premium-quality system used in single-family homes and light commercial building applications. Available with a heavier gauge material in both 2" x 3" (51 x 76) and 3" x 4" (76.2 x 101.6) downspout sizes to accommodate most rain removal requirements.

Envoy® 6" works best on large homes where a bigger system will enhance the architecture, or apartments, multi-family complexes and other light commercial buildings. Designed to be a heavy-duty, large-capacity rain removal system, it is available with a 3" x 4" (76 x 102) downspout.

DIMENSIONS

Gutters

Envoy® 5": nominal .032 (.813) thickness, 16'0" (4877), 21'0" (6401), 26'0" (7925), 33'0" (10058) and 37'0" (11278) lengths, six hangers

Envoy® 6": nominal .032 (.813) thickness, 21'0" (6401) and 37'0" (11278) lengths, four hangers

Downspouts

2" x 3" (51 x 76): nominal .024 (.610) thickness, 10'0" (3048)

3" x 4" (76 x 102): nominal .024 (.610) thickness, 10'0" (3048)

2" x 3" (51 x 76): nominal .019 (.483) thickness, 10'0" (3048)

3" x 4" (76 x 102): nominal .019 (.483) thickness, 10'0" (3048)

4" x 5" (102 x 127): nominal .027 (.656) thickness, 10'0" (3048)

4" (102): nominal .024 (.610) thickness, 10'0" (3048)

ACCESSORIES

All accessories used with Mastic rain removal systems shall be Mastic accessories designed for use with the gutters and will have the same finish. Mill finish accessory components include eave tubes, hangers and expansion joints.

Roof aprons: nominal .027 (.686) thickness

End caps: nominal .024 (.610) thickness both in the Envoy® 5" and the Envoy® 6"

Inside and outside miters: nominal .032 (.813) thickness

Sealant material: Mastic Gutterseal

Expansion joints: aluminum lined with neoprene

Downspout clips: nominal .024 (.356) thickness

NOTE: All measurements noted in () are in millimeters (mm).

PROTECTION

Direct contact of aluminum products with certain dissimilar materials, or contact with water run-off from dissimilar materials, is likely to result in corrosion. See warranty and installation instructions for more details.

WARRANTY

Sectional rain removal systems have a Mastic V.I.P. Limited Lifetime Warranty. Consult the actual product warranty for complete coverage details.

VENTILATION SYSTEMS

Mastic Vent-A-Systems are designed for use in residential and light commercial applications.

MANUFACTURING PHYSICALS

VAR and VAS Mastic Vent-A-System ridges and Vent-A-Strip vents are made of 3105 aluminum sheet (minimum tensile strength 29,000 psi; minimum yield strength 28,000 psi).

VAR and VAS (except mill finish) have an Alumatel® 2000 finish. The finish is a two-coat acrylic applied in a two-phase operation that includes a corrosion-inhibiting primer and a baked-on, high-performance acrylic topcoat. Prior to painting, the metal receives a special cleaning to assure maximum paint adhesion.

SYSTEM DESCRIPTION

Mastic VAR, installed along the ridge of the building, provides the balance necessary for uniform, continuous airflow when used in conjunction with Vent-A-Strip® or proper soffit venting. Vent-A-Ridge® is designed to afford excellent protection against rain and snow. VAR is available in a low-gloss painted model.

VAS provides the vital balance needed for optimum operation used in conjunction with Mastic VAR, and is designed to reduce harmful condensation and excessive temperature buildup in attic areas.

Mastic Vent Soffit may be used instead of VAS when construction conditions do not permit installation of the lineal product.

Ventilation area (net free area per lineal foot)

VAR	18 square inches (116.13)
VAS (model 70)	8.8 square inches (56.77)
VAS (model 79)	9.9 square inches (63.87)

NOTE: All measurements noted in () are in square centimeters (cm²).

PROTECTION

Direct contact of aluminum products with certain dissimilar materials, or contact with water run-off from dissimilar materials, is likely to result in corrosion. See warranty and installation instructions for more details.

WARRANTY

Mastic Vent-A-Systems are backed by an exclusive V.I.P. Limited Lifetime Warranty. Consult actual product warranty certificates for complete coverage details.

For additional information or questions, please contact 800-962-6973.

Notes:

Notes:

THE PLY GEM PORTFOLIO OF BRANDS



The Total Designed Exterior

Ply Gem Brands and Solutions deliver national coverage of the industry's most comprehensive portfolio of designed exterior products that are perfect for any job—and every home, as well as a full offering of solutions designed to support building professionals.



SIDING



WINDOWS



SHUTTERS



STONE VENEER



FENCE & RAILING



PATIO DOORS



TRIM & MOULDINGS



METAL & RAINWARE



ACCESSORIES

MASTIC[®]

by  Ply Gem

MAKE MORE POSSIBLE.™



We reserve the right to alter, modify or delete items from time to time without notice. Due to printing limitations, colors may not be exactly as shown. Contact your distributor or sales representative for actual product and color samples.



MASTIC.COM | 800-962-6973
5020 Weston Parkway, Cary, NC 27513

© 2025 Mastic Home Exteriors, Inc., part
of **Cornerstone Building Brands, Inc.**
ALL RIGHTS RESERVED.

76101099991112/RevO/MS/IMG/1025



PART OF THE CORNERSTONE BUILDING BRANDS FAMILY